



N8800-100F, EXP320B

NEC Express5800/320Fb-L

N8800-101F, EXP320A

NEC Express5800/320Fb-LR

User's Guide (Setup)

1st Edition

1-2007

856-126409-102-00

PROPRIETARY NOTICE AND LIABILITY DISCLAIMER

The information disclosed in this document, including all designs and related materials, is the valuable property of NEC Corporation (NEC) and /or its licensors. NEC and/or its licensors, as appropriate, reserve all patent, copyright and other proprietary rights to this document, including all design, manufacturing, reproduction, use, and sales rights thereto, except to the extent said rights are expressly granted to others.

The NEC product(s) discussed in this document are warranted in accordance with the terms of the Warranty Statement accompanying each product. However, actual performance of each such product is dependent upon factors such as system configuration, customer data, and operator control. Since implementation by customers of each product may vary, the suitability of specific product configurations and applications must be determined by the customer and is not warranted by NEC.

To allow for design and specification improvements, the information in this document is subject to change at any time, without notice. Reproduction of this document or portions thereof without prior written approval of NEC is prohibited.

First Printing, January 2007
Copyright 2007
NEC Corporation
7-1 Shiba 5-Chome, Minato-Ku
Tokyo 108-8001, Japan
All Rights Reserved
Printed in Japan



Keep this User's Guide handy for quick reference when necessary.

Safety Indications



To use NEC Express5800 series safely, follow the instructions in this User's Guide.

This guide explains components that pose a danger, types of dangers caused by failing to follow the instructions, and actions taken to prevent them; such components are labeled warning.

This guide and warning labels use "WARNING" and "CAUTION" to indicate a danger depending on the degree. These terms are defined as follows:



 WARNING	Indicates a danger that could lead to a death or serious injury.
 CAUTION	Indicates a danger that could lead to a burn, other injuries or damage to physical assets.

This guide uses the following three types of symbols to give indications and precautions against a danger. They are defined as follows:

	Indicates that there is a risk of a danger. Each image symbolizes a particular type of danger. (Attention)
	Indicates what you must not do. Each image symbolizes a particular type of prohibition. (Prohibited actions)
	Indicates what you must do. Each image symbolizes a particular type of action necessary to avoid a danger. (Mandatory actions)

(Example)









Symbol to draw attention
Term indicating a degree of danger

 CAUTION	
	High temperature. Immediately after the power-off, system components such as hard disk are very hot. Wait the server to cool down completely before adding/removing some component.







Symbol indicating a prohibited action (may not always be indicated) Description of a danger

Symbols and its descriptions used in this User’s Guide and warning labels are as follows:



Attention

	Indicates a risk of an electric shock.
	Indicates a risk of a personal injury due to heat.
	Indicates a risk of catching your fingers.
	Indicates a risk of a fire or smoke.
	Indicates a general precaution or warning that is not defined herein.
	Indicates a risk of losing eyesight due to laser beam.
	Indicates a risk of an explosion.
	Indicates a risk of a personal injury.

Prohibited actions

	Indicates a general prohibition that is not defined herein.
	Do no touch the indicated area. There is a risk of an electric shock or fire.
	Do not touch with wet hands. There is a risk of an electric shock.
	Keep from flame. There is a risk of a fire.
	Avoid using water or liquid nearby. If it spills on the equipment, there is a risk of an electric shock or fire.
	Do not disassemble, repair, or modify the equipment. There is a risk of an electric shock or fire.

Mandatory actions

	Unplug the server. There is a risk of an electric shock or fire.
	Indicates a general action to take that is not defined herein. Make sure to follow the instructions.

For detailed notes to set up the machine safely, refer to “NOTES FOR SAFE HANDLING” on page 1-2.

NOTE: This equipment has been tested and found to comply with the limits for a Class A digital device, pursuant to Part 15 of the FCC Rules. These limits are designed to provide reasonable protection against harmful interference when the equipment is operated in a commercial environment. This equipment generates, uses, and can radiate radio frequency energy and, if not installed and used in accordance with the instruction manual, may cause harmful interference to radio communications. Operation of this equipment in a residential area is likely to cause harmful interference in which case the user will be required to correct the interference at his own expense.

警告使用者：

這是甲類的資訊產品，在居住的環境中使用時，可能會造成射頻干擾，在這種情況下，使用者會被要求採取某些適當的對策。

이 기기는 업무용으로 전자파적합등록을 한 기기이오니 판매자 또는 사용자는 이 점을 주의하시기 바라며 만약 잘못된 판매 또는 구입하였을 때에는 가정용으로 교환하시기 바랍니다.

This class A digital apparatus meets all requirements of the Canadian Interference-Causing Equipment Regulations.

Cet appareil numérique de la classe A respecte toutes les exigences du Règlement sur le matériel brouilleur du Canada.

CE Statement

Warning: This is a Class A product. In residential environment, this product may cause radio interference, in which case the user may be required to take adequate measures (EN55022).

**CLASS 1
LASER PRODUCT**

This system is classified as a CLASS 1 LASER PRODUCT. This label is located on the internal CD-ROM installed in your system.

NOTE: This product provides resistance against hardware faults with its redundant hardware modules. However, this does not mean complete fault-tolerance is assured. For example, there is a risk of system down when:

- A fatal fault occurs in software.
- Both modules within a redundant hardware pair break down.
- A fatal fault occurs in a non-redundant component, such as the clock generator circuitry or the interconnect backplane.
- The entire system is cut off from AC power.



安全注意事項

安全標示



請參考本用戶指南中的指示以安全使用NEC Express5800系列伺服器。

本用戶指南說明了設備何處有危險、危險類型、如何避免危險等。在設備可預計到的危險之處或其附近貼有警告標籤。

用戶指南及警告標籤中，根據危險程度不同，使用“警告”、“注意”等詞，含義如下：

 WARNING	表示如不遵守該指示，可能引發人員傷亡。
 CAUTION	表示如不遵守該指示，可能發生燒傷等身體損傷或造成物質損失。



對危險的提示表示有如下三種符號，具體含義如下所述：

	表示該處可能發生危險。符號為危險內容的圖案。（注意）
	表示禁止行爲。符號中或其附近的圖案為禁止行爲內容。（禁止行爲）
	表示強制行爲。符號中的圖案為強制必須做的行爲內容。即為避免危險必需的行爲。（強制行爲）

（用戶指南中範例）

注意符號

表示危險程度的用語









 CAUTION	
	注意高溫。 本產品關閉電源後，內置硬碟等內部設備仍然處於高溫狀態。請在充分冷卻之後進行拆裝。

禁止行爲的提示符號（有可能沒有此類提示）







危險提示內容

本書及警告標籤中使用的符號



注意

	表示有觸電的危險。
	表示有因高溫而負傷的危險。
	表示有手指等被夾住的危險。
	表示有冒煙或者著火的危險。
	表示非特定的一般的提醒警告。
	表示有因雷射導致失明的危險。
	表示有爆炸的危險。
	表示有受傷的危險。

禁止行爲

	表示非特定的一般禁止。
	不要觸摸指定區域。有觸電或著火的危險。
	不要用濕手觸摸。有觸電的危險。
	遠離火源。有著火的危險。
	遠離液體。如果沾到液體，有觸電或著火的危險。
	請不要對本設備進行拆卸、修理、改造。有觸電和發生火災的危險。

強制行爲

	請將本設備的電源插頭從伺服器上拔下。有發生火災和觸電的危險。
	對非特定的一般使用者的行爲進行指示。請按照說明進行操作。

NOTE: This equipment has been tested and found to comply with the limits for a Class A digital device, pursuant to Part 15 of the FCC Rules. These limits are designed to provide reasonable protection against harmful interference when the equipment is operated in a commercial environment. This equipment generates, uses, and can radiate radio frequency energy and, if not installed and used in accordance with the instruction manual, may cause harmful interference to radio communications. Operation of this equipment in a residential area is likely to cause harmful interference in which case the user will be required to correct the interference at his own expense.

警告使用者：

這是甲類的資訊產品，在居住的環境中使用時，可能會造成射頻干擾，在這種情況下，使用者會被要求採取某些適當的對策。

**CLASS 1
LASER PRODUCT**

這是CLASS 1 LASER PRODUCT。該標籤貼於系統的內部光碟。

注意：本產品通過多餘的硬體模組提供硬體容錯性能。但是這並不表示能夠保證完全容錯。

如，在以下情況下可能發生宕機：

- 軟體發生致命故障。
- 多餘硬體雙方均發生故障，不能運行。
- 時鐘產生器線路或內部連接背板等非多餘元件發生致命故障。
- 切斷了整個系統的AC電源

Trademarks and Patents

NEC EXPRESSBUILDER and NEC ESMPRO are trademarks of NEC Corporation.

Microsoft, Windows, Windows Server, Windows NT, and MS-DOS are registered trademarks of Microsoft Corporation in the United States and other countries.

Intel and Pentium are registered trademarks of Intel Corporation.

AT is a registered trademark of International Business Machines Corporation in the United States and other countries.

Adobe, the Adobe logo, Acrobat, and the Acrobat logo are trademarks of Adobe Systems Incorporated.

Datalight is a registered trademark of Datalight, Inc. ROM-DOS is a trademark of Datalight, Inc.

Xeon is a trademark of Intel Corporation in the United States. DLT and DLTape are trademarks of Quantum Corporation in the United States. Fast!UTIL is a trademark of QLogic Corporation in the United States.

Avocent and Dambrackas Video Compression (DVC) are trademarks or registered trademarks of Avocent Corporation in the United States and other countries.

Mozilla is a trademark of Mozilla Foundation.

Netscape is a trademark or registered trademark of Netscape Communications Corporation in the United States and other countries. Java is a trademark or registered trademark of Sun Microsystems, Inc. in the United States and other countries.

Linux is a registered trademark of Linux Torvalds. Red Hat and RPM are trademarks or registered trademarks of Red Hat, Inc. in the United States and other countries.

All other product, brand, or trade names used in this publication are the trademarks or registered trademarks of their respective trademark owners.

Microsoft Windows Server 2003 Standard Edition operating system and Microsoft Windows Server 2003 Enterprise Edition operating system are called Windows Server 2003 for short. Microsoft Windows 2000 Server operating system, Microsoft Windows 2000 Advanced Server operating system and Microsoft Windows 2000 Professional operating system are called Windows 2000 for short. Microsoft Windows NT Server network operating system version 3.51/4.0 and Microsoft Windows NT Workstation operating system version 3.51/4.0 are called Windows NT for short. Microsoft Windows Millennium Edition Operating System is called Windows Me for short. Microsoft Windows 98 operating system is called Windows 98 for short. Microsoft Windows 95 operating system is called Windows 95 for short.

Names used with sample applications are all fictitious. They are unrelated to any existing product names, names of organizations, or individual names.

Most of the software used for this server can be redistributed free under the terms of the BSD Copyright and the GNU Public License. However, there is software that requires permissions for redistribution as the owners have the ownership. For details, see "Introduction" in the attachment.

The Dambrackas Video Compression algorithm from Avocent Corporation is used for ft Remote Management Card.

U.S. Patent Numbers: 5,732,212, 5,937,176, 6,633,905, 6,681,250, 6,701,380 and other patents pending

Taiwanese Patent Number: 173784

European Patent Number: 0 740 811

Notes:

- (1) No part of this manual may be reproduced in any form without prior written permission of NEC Corporation.
- (2) The contents of this manual are subject to change without prior notice.
- (3) The contents of this manual shall not be copied or altered without prior written permission of NEC Corporation.
- (4) All efforts have been made to ensure the accuracy of all information in this manual. If you find any part unclear, incorrect, or omitted in this manual, contact the sales agent where you purchased this product.
- (5) NEC assumes no liability arising from the use of this product, nor any liability for incidental or consequential damage arising from the use of this manual regardless of (4) above.

Preface

Welcome to the NEC Express5800/ft series.

NEC Express5800/ft series is a “fault-tolerant (ft)” server focusing on “high reliability” in terms of fault-tolerance, in addition to “high performance,” “scalability,” and “general versatility” provided by NEC Express5800 series. In the event of trouble, its dual configuration will allow the system to instantaneously isolate the failed parts to assure non-stop running; operation will be moved smoothly from one module to the other, minimizing damage to it. You can use NEC Express5800/ft series in a mission-critical system where high availability is required. By the use of Linux operating system, it also provides outstanding openness for general-purpose applications, etc.

To make the best use of these features, read this User's Guide thoroughly to understand how to operate NEC Express5800/ft series.

About This User's Guide

This User's Guide helps a user to properly setup and use the product. Consult this guide when you set up the product.

Keep this manual and the separate volume of User's Guide handy.

This User's Guide is intended for users who have a good knowledge on the basic use of Linux operating systems and general I/O devices such as a keyboard and mouse.

How to Use This User's Guide

This guide explains the procedures you should perform before you begin system operation after you purchased the product. Read the guide in order from Chapter 1. If you perform procedures according to this guide, you will set up the product properly.

Chapter 4 describes how to install the operating system. Chapter 5 describes post-installation procedures. Chapter 6 explains how to troubleshoot if you cannot set up the product properly. Refer to "SYSTEM REPAIR" on page 6-2 for details about system configurations and repairs of this product. Refer to "TROUBLESHOOTING" on page 6-3 if you feel you failed to set up the product.

See this User's Guide for details of this product's operation, and functions and operations of the hardware and the system.

Additional symbols

The following symbols are used throughout this User's Guide in addition to the caution symbols described at the beginning.

IMPORTANT:	Important points or instructions to keep in mind when using the server or software
CHECK:	Something you need to make sure when using the server or software
TIPS:	Helpful information, something useful to know

About our Web Service

Information on NEC Express5800/ft series including modification modules is also available on our web site, NEC Express5800 Web Site Asia Pacific, at

<http://www.nec.co.jp/express/index.html>

Contents

Preface	iii
About This User's Guide	iv
How to Use This User's Guide.....	iv
Additional symbols	v
About our Web Service.....	v
CHAPTER 1 BEFORE USING	1-1
NOTES FOR SAFE HANDLING	1-2
Warning Labels.....	1-2
CPU/IO Modules	1-4
PRECAUTIONS FOR SAFETY	1-5
General.....	1-5
Use of Power Supply and Power Cord.....	1-6
Installation, Relocation, Storage and Connection	1-7
Cleaning and Handling of Internal Devices	1-8
During Operation	1-9
Rack-mount Model (Model 320Fb-LR).....	1-10
安全注意事項	1-12
一般注意事項	1-12
使用電源及電源線注意事項.....	1-13
安裝，移動，保管及連接注意事項.....	1-14
整理及操作內部設備時的注意事項.....	1-15
操作注意事項	1-16
機架式伺服器的注意事項.....	1-17
UNPACKAGING	1-19
Accessories	1-19
CHAPTER 2 ABOUT OPERATING SYSTEM	2-1
INSTALLING MIRACLE LINUX V4.0 SP1	2-2
About OS installation.....	2-2
CHAPTER 3 INSTALLING SERVER	3-1
INSTALLATION	3-2
Tower Model.....	3-2
Rack-mount Model	3-4
Connection.....	3-7

CHAPTER 4 LINUX SETUP	4-1
SETUP FLOW	4-2
SETUP PROCEDURE	4-3
Step 1: Starting Setup Procedure When Reinstalling the OS.....	4-3
Step 2: Prepare for Installation	4-4
Step 3: Disable the Startup Monitoring Function Setting	4-6
Step 4: Install MIRACLE LINUX V4.0 SP1.....	4-11
Step 5: Install Software Provided by NEC Express5800/ft series	4-33
Step 6: Set Dual Configuration of LAN Cards	4-35
Step 7: Set Dual Disk Configuration	4-40
Step 8: Connect and Configure Options	4-46
Step 9: Create Volume.....	4-46
Step 10: Set Network for NEC ESMPRO Agent.....	4-46
Step 11: Enable Boot Monitoring Function	4-47
Step 12: Modify BIOS Setup	4-48
Step 13: Back up System Information	4-51
CHAPTER 5 PROCEDURES AFTER COMPLETION OF INSTALLATION	5-1
INSTALLING MANAGEMENT UTILITIES	5-2
NEC ESMPRO Agent.....	5-2
NEC ESMPRO Manager	5-8
NEC DianaScope.....	5-8
CONFIRMATION OF THE KERNEL VERSION	5-9
CHAPTER 6 TROUBLESHOOTING	6-1
SYSTEM REPAIR	6-2
TROUBLESHOOTING	6-3
Problems with NEC EXPRESSBUILDER.....	6-3
APPENDIX A ABOUT SERVICES	A-1

(This page is intentionally left blank.)

Chapter 1

Before Using

This chapter includes information necessary for proper and safe operation of the server, the main unit and its accessories. Go through this chapter before you start setup of the product.

NOTES FOR SAFE HANDLING

The following section describes necessary information to use the product properly and safely.

Warning Labels

Warning labels are placed in certain parts of the system so that the user stays alert to possible risks (Do not remove or damage these labels).

If some label is missing, about to peel off, or illegible, contact your sales agent.

The figures below show locations of the labels on the server.

Tower model

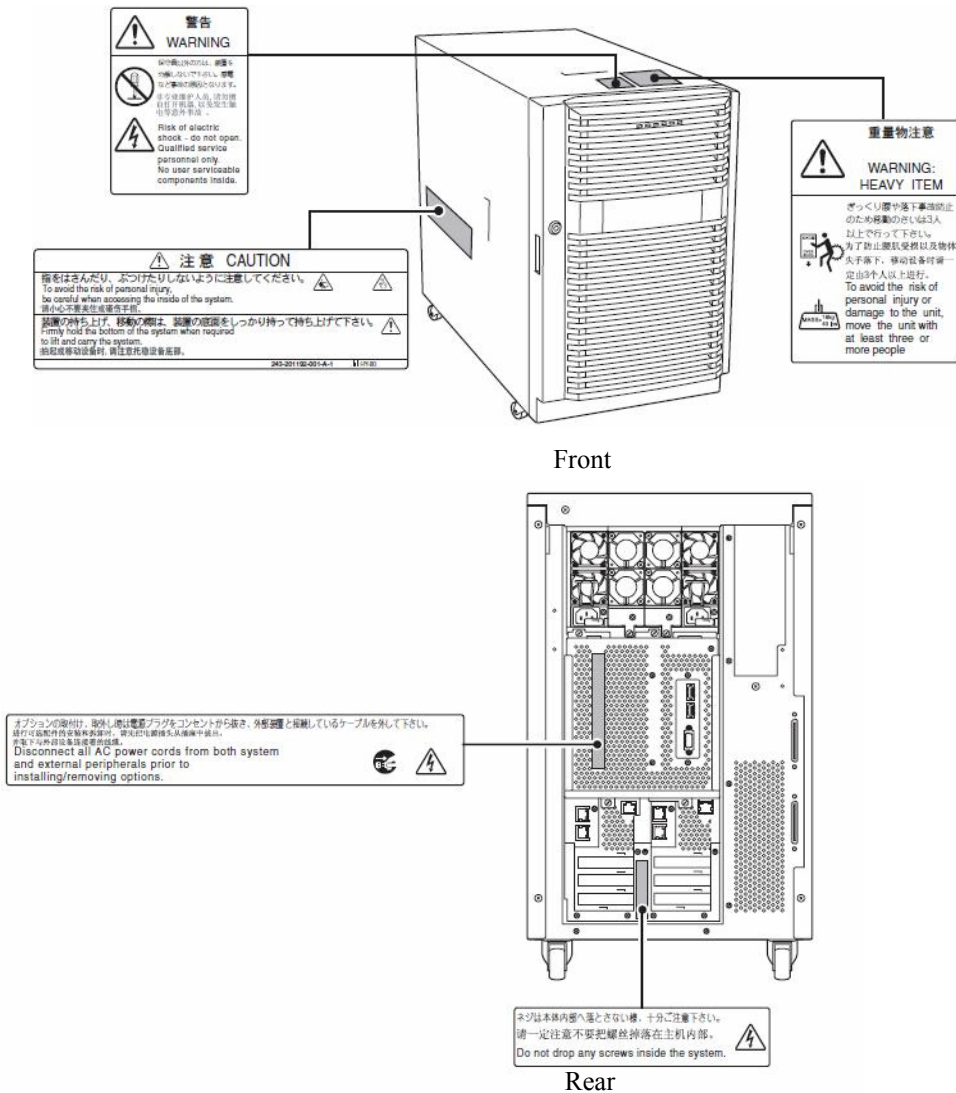

Front

Rear

Rack Model

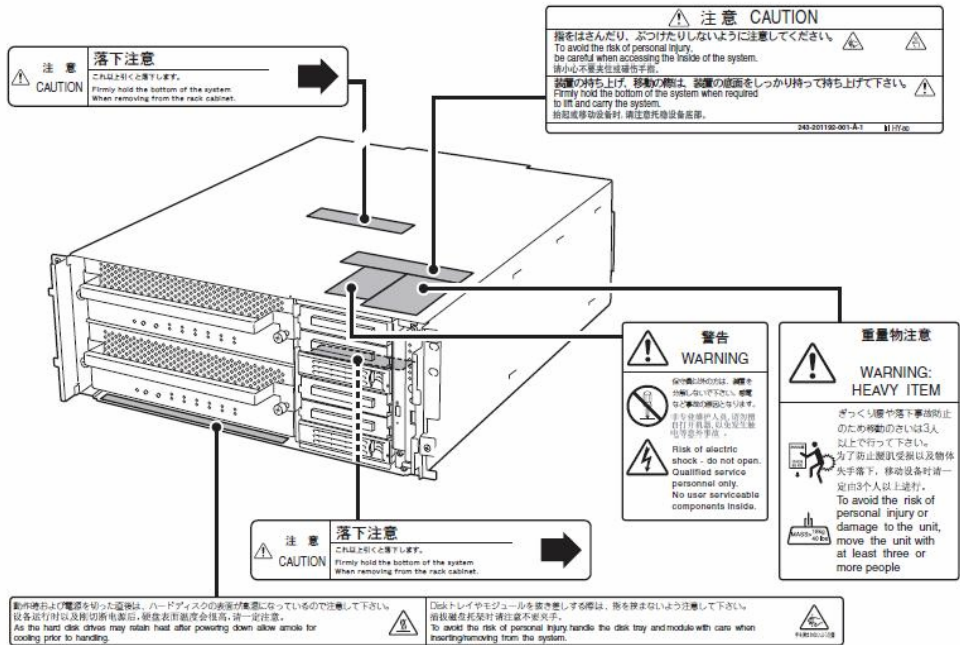

Front

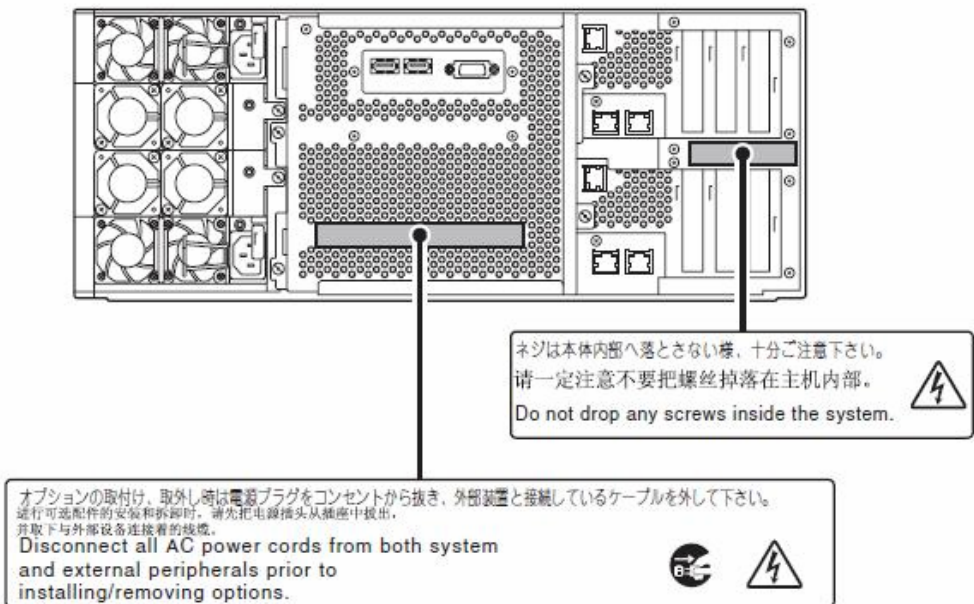

Rear

CPU/IO Modules

The following shows the place on CPU/IO modules where the label is attached.

Standard Model

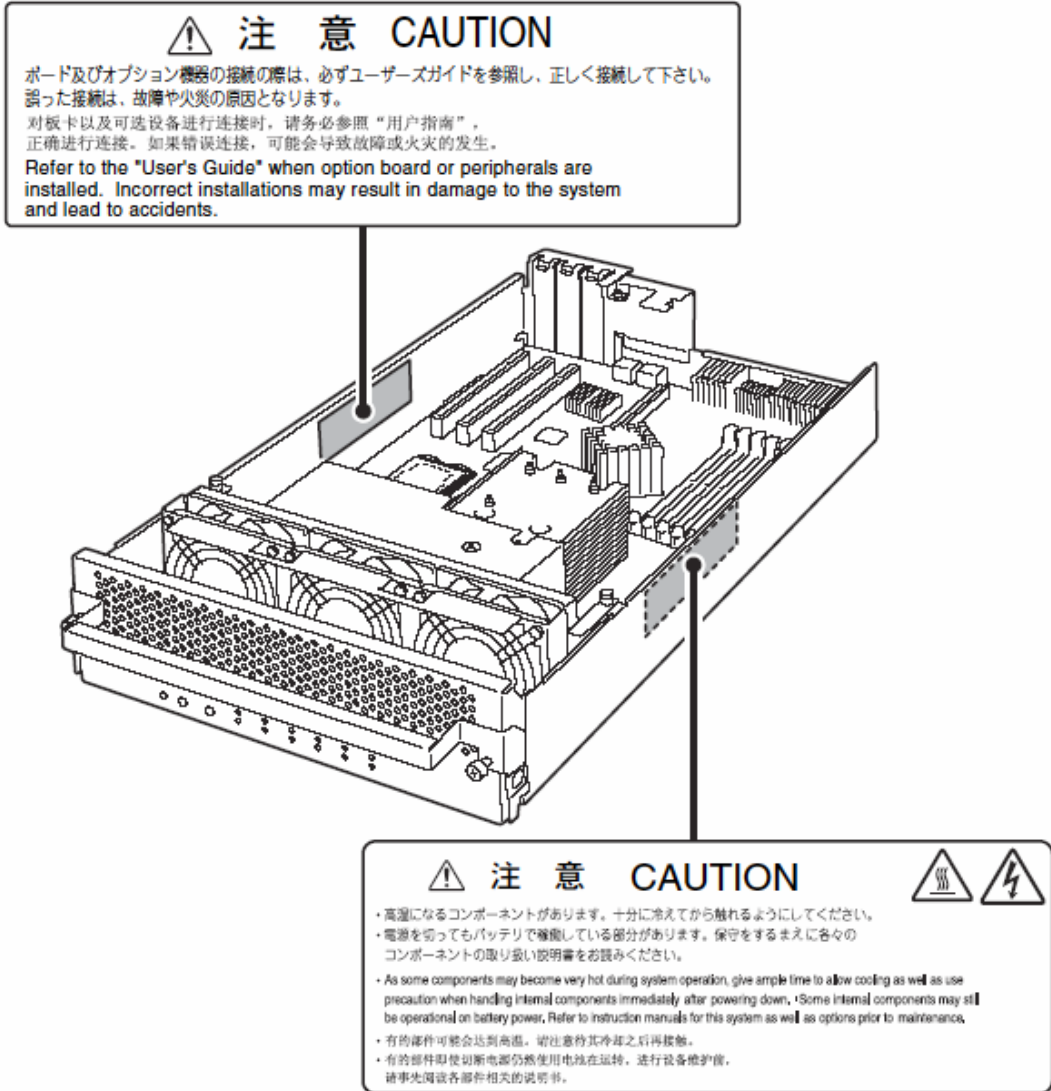

PRECAUTIONS FOR SAFETY

This section provides precautions for using the server safely. Read this section carefully to ensure proper and safe use of the server. For symbol meanings, see “Safety Indications” described in the previous section.

General

WARNING



Do not use the server in an operation where human lives are involved or high reliability is required.

This equipment is not intended for use in controlling or use with facilities or systems where human lives are involved or high reliability is required, including medical devices or nuclear, aerospace, transportation, and traffic control facilities. NEC assumes no liability for any accidents or damage to physical assets resulting from the use of this equipment in such systems or facilities.



Do not continue to use the server if you detect smoke, odor, or noise.

If the server emits smoke, odor, or noise, immediately flip off the POWER switch, unplug the cords, and contact your sales agent. There is a risk of a fire.



Do not insert a wire or metal object.

Do not insert a wire or metal objects into a vent or disk drive slot. There is a risk of an electric shock.

CAUTION



Prevent water or foreign objects from getting into the server.



Do not let water or foreign objects (e.g., pins or paper clips) enter the server. There is a risk of a fire, electric shock, and breakdown. When such things accidentally enter the server, immediately turn off the power and unplug the cords. Contact your sales agent instead of trying to disassemble it yourself.

Use of Power Supply and Power Cord

WARNING



Do not handle power plugs with a wet hand.

Do not plug/unplug power cords with a wet hand. There is a risk of an electric shock.



Do not connect the ground wire to a gas pipe.



Never connect the ground wire to a gas pipe. There is a risk of a gas explosion.

CAUTION



Do not plug the cords in nonconforming outlets.



Use wall outlets with specified voltage and power type. There is a risk of a fire or current leakage.

Avoid installing the server where you may need extension cords. If the cords do not meet the power specifications, there is a risk of overheating that could lead to a fire.



Do not plug too many cords in a single outlet.

If the rated current is exceeded, there is a risk of overheating that could lead to a fire.



Do not plug the cords insecurely.



Insert the plug firmly into an outlet. There is a risk of heat or fire due to poor contact. If dust settles on the slots and it absorbs moisture, there is also a risk of heat or fire.



Do not use nonconforming power cords.



AC cord is to spend the thing of the next specifications:

Maximum 4.5m (14.76ft) long. Rated minimum 125V, 10A, Type SJT flexible cord.

You also have to observe the following prohibitions to prevent an electric shock or fire caused by damage to the cords.

- Do not pull on the cords.
- Do not pinch the cords.
- Do not bend the cords.
- Keep chemicals away from the cords.
- Do not twist the cords.
- Do not place any object on the cords.
- Do not use cords as bundled.
- Do not alter, modify, or repair the cords.
- Do not staple the cords.
- Do not use any damaged cord. (Replace it with a new one of the same specifications. For replacement procedures, contact your sales agent.)

Installation, Relocation, Storage and Connection

CAUTION



Do not install the server in an unsuitable place.

Install the server in such a place as specified in this User's Guide. Avoid the following locations. There is a risk of a fire.

- a dusty place
- a humid place located near a boiler, etc
- a place exposed to direct sunlight
- an unstable place



Do not use or store this product in a corrosive environment.

Avoid the usage or storage of this product in an environment which may be exposed to corrosive gases, such as those including but not limited to : sulfur dioxide, hydrogen sulfide, nitrogen dioxide, chlorine, ammonia and/or ozone. Avoid installing NEC Express5800/ft series in a dusty environment or one that may be exposed to corrosive materials such as sodium chloride and/or sulfur.

Avoid installing this product in an environment that may have excessive metal flakes or conductive particles in the air.

Such environments may cause corrosion or short circuits within this product, resulting in not only damage to this product, but may even lead to be a fire hazard. If there are any concerns regarding the environment at the planned site of installation or storage, please contact your sales agent.



Do not use any non-designated interface cable.

Use only interface cables designated by NEC; identify which component or connector to attach beforehand. If you use a wrong cable or make a wrong connection, there is a risk of short-circuit that could lead to a fire.

You also have to observe the following prohibitions about handling and connecting interface cables:

- Do not use any damaged cable connector.
- Do not step on the cable.
- Do not place any object on the cable.
- Do not use the server with loose cable connections.
- Do not use damaged cables.

Cleaning and Handling of Internal Devices

WARNING



Do not disassemble, repair, or alter the server.



Unless described herein, never attempt to disassemble, repair, or alter the server. There is a risk of an electric shock or fire as well as malfunction.



Do not look into the CD-ROM drive.



The CD-ROM drive uses a laser beam. Do not look or insert a mirror inside while the system is on. A laser beam is invisible; if your eyes get exposed to it, there is a risk of losing eyesight.



Do not detach a lithium battery yourself.

This equipment has a lithium battery. Do not detach it yourself. If the battery is exposed to fire or water, it could explode. When the lithium battery is running down and the server does not work correctly, contact your sales agent instead of disassembling, replacing or recharging it yourself.



Disconnect the power plugs before cleaning the server.



Even though built-in options for the server can be replaced while the power cords are connected to power source, be sure to follow the instructions described in this User's Guide. Do not touch any internal device of the server unless instructed by this User's Guide. There is a risk of an electric shock.

Make sure to power off the server and disconnect the power plug from a power outlet before cleaning or installing/removing internal optional devices. Touching any internal device of the server with its power cords connected to power source may cause an electric shock even if the server is off-powered.

Disconnect the power plug from the outlet occasionally and clean the plug with a dry cloth. Heat will be generated if condensation is formed on a dusty plug, which may cause a fire.

CAUTION



High temperature

Immediately after powering off the system, system components such as hard disk may be very hot. Wait for the server to cool down completely before adding/removing components.



Make sure to completely insert cables and boards.

Completely insert all power cords, interface cables and/or boards. An incompletely inserted component may cause a contact failure, resulting in fire and/or smoke.

⚠ CAUTION

Protect the unused connectors with the protective cap.

The unused power cord connectors are covered with the protective cap to prevent short circuits and electrical hazards. When removing the power cord connector from the internal devices, attach the protective cap to the connector. Failure to follow this warning may cause a fire or an electric shock.

During Operation**⚠ CAUTION**

Keep animals away.

Keep animals away from the server. Animal's waste or hair may get inside the server to cause a fire or electric shock.



Do not place any object on top of the server.

The object may fall off to cause injuries, damage to hardware and/or a fire.



Do not leave the CD tray ejected.

Dust may get in the server to cause malfunction. The ejected tray may also become a cause of injuries.



Do not touch the server when it thunders.

Unplug the server when it threatens to thunder. If it starts to thunder before you unplug the server, do not touch the server or cables. There is a risk of a fire or electric shock.



Do not use a cellular phone or pager around the server.

Turn off your cellular phone or pager when you use the server. Their radio waves may cause the server to malfunction.

Rack-mount Model (Model 320Fb-LR)

WARNING



Do not install the server on a nonconforming rack.

Install the server on a 19-inch rack conforming to the EIA standard. Do not use the server without a rack or install it on a nonconforming rack. The server may not function properly, and there is a risk of damage to physical assets or injuries. For suitable racks, contact your sales agent.



Do not use the server in an unsuitable place.

Do not install a server rack in an unsuitable environment. Other systems also may be affected, and the rack may fall over to cause a fire or injuries. For details about installation environment and quake-resistant engineering, see the attached manual or contact your sales agent.

CAUTION



Be careful not to hurt your fingers.

Exercise great care not to hurt your fingers on the rail when you mount/dismount the server into/from the rack.



Carry or install the server by more than 3 people.

To avoid a risk of injuries, users should not attempt to carry or install the server into a rack. Installation should be performed by trained maintenance personnel.



Do not install the server in such a manner that its weight is imposed on a single place.

To distribute the weight, use stabilizers or attach two or more racks. Unstable rack may fall down to cause injuries.



Do not assemble parts alone.

It takes at least two people to mount doors and trays to a rack. If you handle them alone, you may drop some parts to cause a breakage or injuries.



Do not pull a device out of the rack if the rack is unstable.

Before pulling out a device, make sure that the rack is fixed (by stabilizers or quake-resistant engineering).



Do not leave more than one device pulled out from the rack.

If you pull out more than one device, the rack may fall down. You can only pull out one device at a time.

⚠ CAUTION

Do not install excessive wiring.



To prevent burns, fires, and damage to the server, make sure that the rated load of the power branch circuit is not exceeded. For more information on installation and wiring of power-related facilities, contact your electrician or local power company.



Do not pull out a device during operation.

Do not pull out or remove a device while it is running. There is a risk of malfunction and a device may be detached from a rack to cause injuries.

安全注意事項

本節講述安全使用本伺服器所需的注意事項。爲了您正確安全地使用本伺服器，請仔細閱讀該節內容。符號的相關說明請參考“安全標示（SAFETY INDICATIONS）”說明。

一般注意事項

WARNING



不要用於危及人命和需要高度可靠性的操作上。

本產品不要安裝在醫療設備、原子能設備、航空宇宙機器、運輸設備等會危及人命以及需要高度可靠性的設備和機器上，也不要使用本產品來控制這些機器。如果將本產品用於這類系統的設備及機器，造成人身事故及財產損失等後果，本公司概不負責。



發生冒煙、異味、雜音時不要使用。

發生冒煙、異味、雜音等時，請直接關閉電源POWER，並將電源插頭從插座上拔下。然後請與經銷商或維護服務公司聯繫。繼續使用會導致火災。



不要插入鐵絲和金屬片。

不要將金屬片和鐵絲等異物插入通氣孔或軟碟機、光碟機的縫隙。有觸電的危險。

CAUTION



設備內不要進水和異物。



設備內不要進入水、針、夾子等異物。有可能導致火災和觸電。一旦進入異物，請立即關閉電源，將電源插頭從插座上拔下來。不要自行拆卸，請與經銷商或維護服務公司聯繫。

使用電源及電源線注意事項

⚠ WARNING



不要用濕手拿電源插頭。

不要用濕手插拔電源插頭。有觸電的危險。



不要把地線連接到煤氣管道上。



請勿將地線連接到煤氣管道上。有導致煤氣爆炸的危險。

⚠ CAUTION



不要插入未指定的插座。

電源請使用指定電壓及電源的壁式插座。使用未指定的電源會造成火災和漏電。請避免使用延長線安裝設備。如果連接與本產品電源規格不相符的電線，會因過熱而導致火災。



不要在一個插座上插接多個電源線。

插座如果超過額定電流，會因過熱而導致火災的危險。



不要只插入一半。

請將電源插頭直插到底部。如果插入一半會因接觸不良而發熱，造成火災。另外，插入部如附著灰塵、水滴等，會因發熱導致火災。



不要使用未指定的電源線。

請使用下列規格的AC電源線。
最長4.5m (14.76 ft)，最小額定電壓125V，10A，SJT電源線。
此外，操作和連接電源線時請遵循以下注意事項。

- 不要拖拽電源線。
- 不要夾電源線。
- 不要彎折電源線。
- 不要使電源線靠近化學藥品。
- 不要扭曲電源線。
- 不要踩踏電源線。
- 不要在電源線上載入物品。
- 不要捆綁電源線。
- 不要對電源線進行改造、加工、修復。
- 不要用固定器等固定電源線。
- 不要使用損傷的電源線。（損傷的電源線要立即更換為相同規格的電源線。更換事宜請與經銷商或維護服務公司聯繫）



安裝，移動，保管及連接注意事項

⚠ CAUTION



不要安裝或存放在未指定的場所。

不要將本設備放置在如下場所和本書未指定的場所，有導致火災的危險。

- 灰塵較多的場所
- 熱水器旁等濕氣較高的場所
- 陽光直射的場所
- 不平穩的場所



不要在腐蝕性環境中使用或存放設備。

不要在有腐蝕性氣體（如二氧化硫、氫化硫、氮、氫、氨或臭氧等）的環境中使用或存放本產品。

不要將本產品安裝在灰塵較多或含有腐蝕性物質如氯化鈉或硫磺等的地方。

不要將本產品安裝在空氣中含有過量金屬碎末或傳導粒子的地方。

上述環境可能導致本產品腐蝕或短路，因而損壞產品，甚至引起火災。

對產品安裝或存放環境有任何疑問，請與經銷商或維修服務公司聯繫。



不要使用未指定的信號線。

使用NEC指定的信號線，並在確認連接設備和介面後進行連接。使用未指定信號線或連接錯誤等會造成短路、導致火災。

信號線的操作和連接，須遵守以下注意事項：

- 不要使用任何損壞的信號線接頭。
- 不要踩踏信號線。
- 不要在信號線上載入物品。
- 信號線接鬆動時不要使用。
- 不要使用任何損壞的信號線。

整理及操作內部設備時的注意事項

⚠ WARNING



不要自行拆卸、修理或改造本伺服器。



除本書記載的情況外，不要進行拆卸、修理、改造。否則，不但可能導致設備不能進行正常運行，還有發生觸電和火災的危險。



不要看光碟機內部。



光碟機使用了雷射，請不要在電源打開的狀態下觀看內部或插入鏡子等。雷射射入眼睛有導致失明的危險（雷射肉眼看不見）。



不要擅自拆除鋰電池。

本產品內部安裝有鋰電池。請不要拆下電池。鋰電池靠近火或浸水均有可能發生爆炸。

由於電池使用期限而導致設備不能正常運行時，不要自行拆卸、更換、充電等，請與經銷商或維護服務公司聯繫。



清潔伺服器前請拔下電源插座。



整理或拆裝本設備內部的選購配置時，要切斷設備電源，並拔下電源插頭。即使已關閉電源，但連接著電源線，接觸到任何內部設備也有觸電的危險。



另外，請經常拔下電源插頭，用乾布擦拭灰塵和附著物。有灰塵或水滴等附著時會發熱，有導致火災的危險。

⚠ CAUTION



注意高溫

本產品關閉電源後，內置硬碟等內部設備仍然處於高溫狀態。請在充分冷卻之後進行拆裝。



確認安裝完畢。

電源線和信號線、配件板要確實安裝妥當。
安裝不牢有可能引起接觸不良，可能造成冒煙和著火。

⚠ CAUTION



請用保護蓋保護好未使用的介面。



請用保護蓋保護好未使用的電源線介面以防止短路或觸電。從內部設備上拔下電源插頭時，用保護蓋蓋好介面，否則有導致火災或觸電的危險。

操作注意事項

⚠ CAUTION



不要讓寵物靠近。



寵物的排泄物和毛髮進入設備可能導致火災和觸電。



設備上不要放置物品。

物品倒下可能引起傷亡，破壞硬體或導致火災。



不要將光碟機托盤拉出放置。

防止托盤中進入灰塵引起運轉錯誤。同時防止因碰撞等造成托盤損傷。



不要在打雷時觸摸機器。

打雷時請拔下電源插頭。如來不及拔下電源插頭，請不要觸摸設備及線纜等，防止發生火災或觸電。



不要在設備附近使用行動電話或呼叫器。

在本產品附近時請關閉行動電話及呼叫器電源，防止因電波影響導致運轉錯誤。

機架式伺服器的注意事項

⚠ WARNING



不要將設備安裝在未指定的機架上。

請將設備安裝在符合EIA標準的19英寸機架上。一定要將設備安裝在指定的機架上才能使用。否則設備可能無法正常使用，並有可能損壞機器零部件或導致人身傷害。關於合適的機架，請與您的經銷商聯繫。



不要在未指定的場所使用本伺服器產品。

不要在未指定的環境中安裝伺服器機架。否則，其他系統可能會受到影響，並且機架脫落可能導致火災或者人身傷害。有關安裝環境和防震技術的詳細事項請參閱附帶的用戶手冊或與經銷商或維護服務公司聯繫。

⚠ CAUTION



請小心不要夾住或碰傷手指。

將本機器安裝到機架上或者從機架上卸載的時候，請務必小心以免被滑軌劃傷手指。



請確同時有三人以上一起進行搬運/安裝此伺服器的動作。

為了避免人身傷害，請不要自行將本機器安裝到機架上。應該由受過專業訓練的維護人員來安裝。



安裝機器時不能將機器的所有重量由一個地方來承載。

為了分散重量，應該加裝固定器或者同時安裝兩個或更多的機架，否則機架可能會傾倒導致人身傷害。



不要擅自組裝零部件。

將前門和托架安裝到機架上至少需要兩人共同完成，否則可能會因為零部件跌落而導致損壞或者人身傷害。



不要從不牢固的機架中抽出設備。

在抽出設備之前請確認機架已經被穩固器或者通過抗震技術固定。

⚠ CAUTION



不要從機架抽出兩個或者兩個以上的設備。
同時抽出兩個或者兩個以上的設備可能導致機架傾倒。一次只能抽出一個設備。



不要裝配過多電線。



爲了避免火災和設備損壞，請務必確保不要超過線路的額定負載。有關電力設備的安裝和電線的更多資訊請聯繫電工或者當地的電力公司。



不要在設備運行時拔出設備。

不要拔出或拆除運行中的設備。有導致系統故障和損壞的危險。

UNPACKAGING

The following section describes necessary information to use the product properly and safely.

Accessories

This product is shipped with various accessories. See the attached list to make sure everything is included and check the individual items. If any component is missing or damaged, contact your sales agent.

- Keep the accessories in a safe place. You will need them when you perform setup, addition of options, or replacement of failed components.
- To check NEC EXPRESSBUILDER components, see the attached list.
- Be sure to fill out and mail the software registration card that is shipped with the operating system.
- Make backup copies of included floppy disks, if any. Keep the original disks as the master disks; use these copies in operation.
- Improper use of an included floppy disk or CD-ROM may alter your system environment. If you find something unclear, stop using them and contact your sales agent.

(This page is intentionally left blank.)

Chapter 2

About Operating System

This chapter gives essential information on the Linux system supported by the server and how to install it.

INSTALLING MIRACLE LINUX V4.0 SP1

For installing an operating system on NEC Express5800/ft series, use Backup CD-ROM.

IMPORTANT:

The NEC Express5800/ft series is a precision instrument. You should ask maintenance personnel to install it.

Before performing the ft series setup, contact your sales agent about the latest release of ft control software.

About OS installation

Read the notes here carefully before installing the operating system.

Operating System Supported by the NEC Express5800/ft series

NEC Express5800/ft series supports the operating system, MIRACLE LINUX V4.0 SP1.

NEC Express5800/ft series does not support any operating systems other than the above.

About MIRACLE LINUX V4.0 SP1

Use the ft series setup program to install MIRACLE LINUX V4.0 SP1. Note the following at installation:

IMPORTANT:

- Complete all the setups such as the memory expansion and the BIOS setting before installing MIRACLE LINUX V4.0 SP1.
 - NEC software package, which is to be purchased separately, is also provided with the documentation for installation. However, see this User's Guide for installation into this server.
 - After completing the ft series setup program, make settings for failure management (e.g., memory dump (debug information) setting) according to Chapter 4.
-

Chapter 3

Installing Server

This chapter describes requirements for using the product properly and safely, the setup procedures to make NEC Express5800/ft series ready for use, and how to connect peripherals.

INSTALLATION

This section describes installation of NEC Express5800/ft series.

Tower Model

IMPORTANT:

NEC Express5800/ft series is a precision instrument. You should ask maintenance personnel to install it.

Select a suitable site for tower model.

⚠ CAUTION



Observe the following precautions to use the equipment safely. There are risks of a burn, injury, or damage to physical assets. For details, see “NOTES FOR SAFE HANDLING” in Chapter 1.

- Remove all modules before moving the equipment.
- Do not install the equipment in non-designated places.

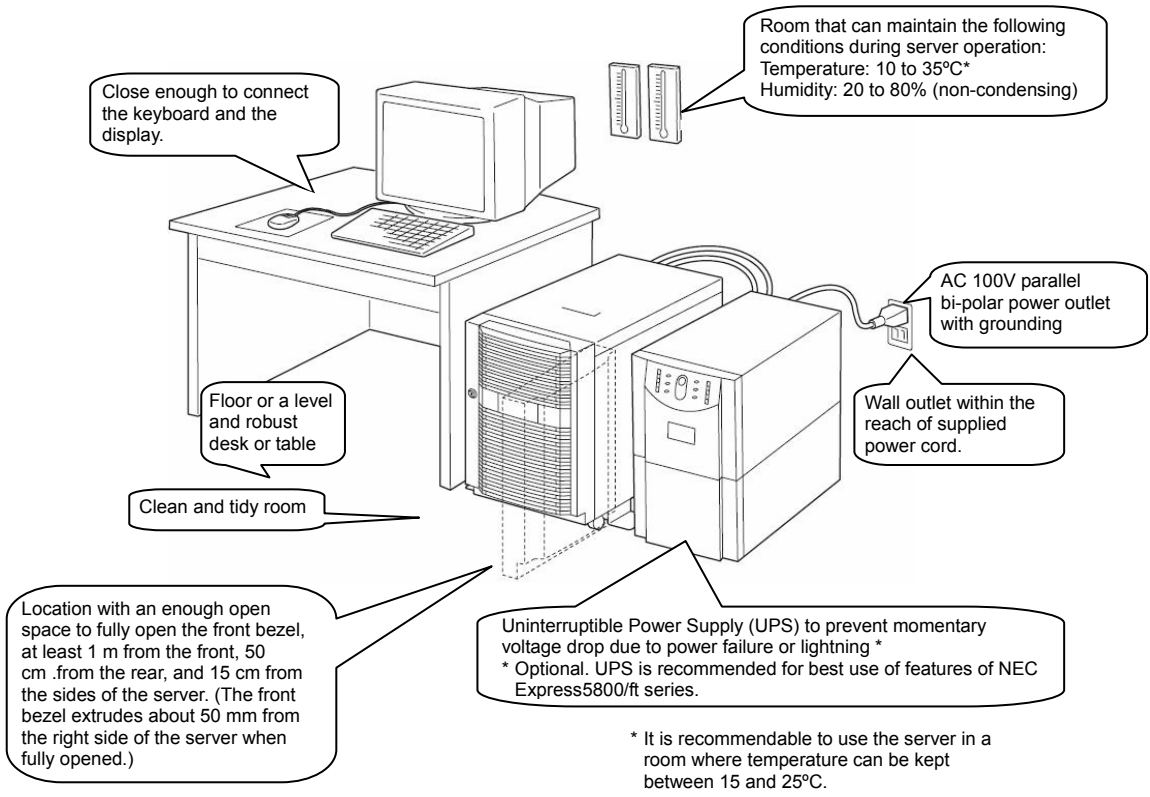

Do not install NEC Express5800/ft series in such places as listed below. Otherwise, the server may malfunction.

- Place where temperatures change widely (near a heater, air conditioner, or refrigerator).
- Place that is subject to intense vibration.
- Place where corrosive gas (sodium chloride, sulfur dioxide, hydrogen sulfide, nitrogen dioxide, or ozone) is generated, or a place that is close to chemicals or exposed to chemicals.
- Place whose floor is covered with non-antistatic carpet.
- Place that may be subject to falling objects.
- Place where you may step or trip on the power cords or interface cables.
- Place that is close to some equipment that generates intense magnetic field (e.g., TV set, radio, broadcasting/communications antenna, power transmission wire, and electromagnetic crane). (If unavoidable, contact your sales agent to request proper shield construction.)
- Place where the power cord of the server must be connected to an AC outlet that shares the outlet of another device with large power consumption.
- Place that is close to some equipment that causes power noises (e.g., sparks caused by power-on/off using a relay). If you must install the server close to such equipment, request your sales agent for separate power cabling or noise filter installation.

It takes at least three people to carry the server; hold it firmly by its bottom and place it slowly on the selected site.

IMPORTANT:

Do not hold the front bezel to lift it, or it may become detached and fall down.

After placing the main cabinet, lock its two front casters out of four and screw the attached four stabilizers on the cabinet adjusting their height.

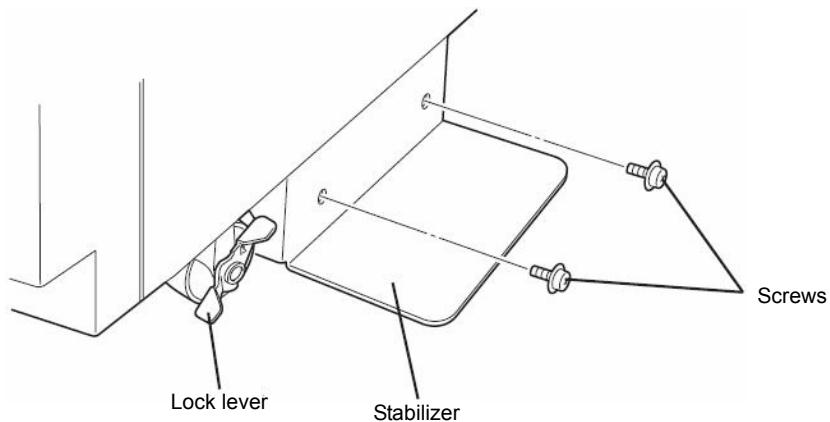

Rack-mount Model

You can mount NEC Express5800/ft series on a rack that conforms to the EIA standards.

IMPORTANT:

NEC Express5800/ft series is a precision instrument. You should ask maintenance personnel to install it.

To install a rack, contact your sales agent or maintenance personnel.

⚠ CAUTION	
	<p>Do not attempt to install the server.</p> <p>To avoid the risk of personal injury, users should not attempt to install the server into the rack assembly. The server should be installed in the rack only by trained maintenance personnel.</p>

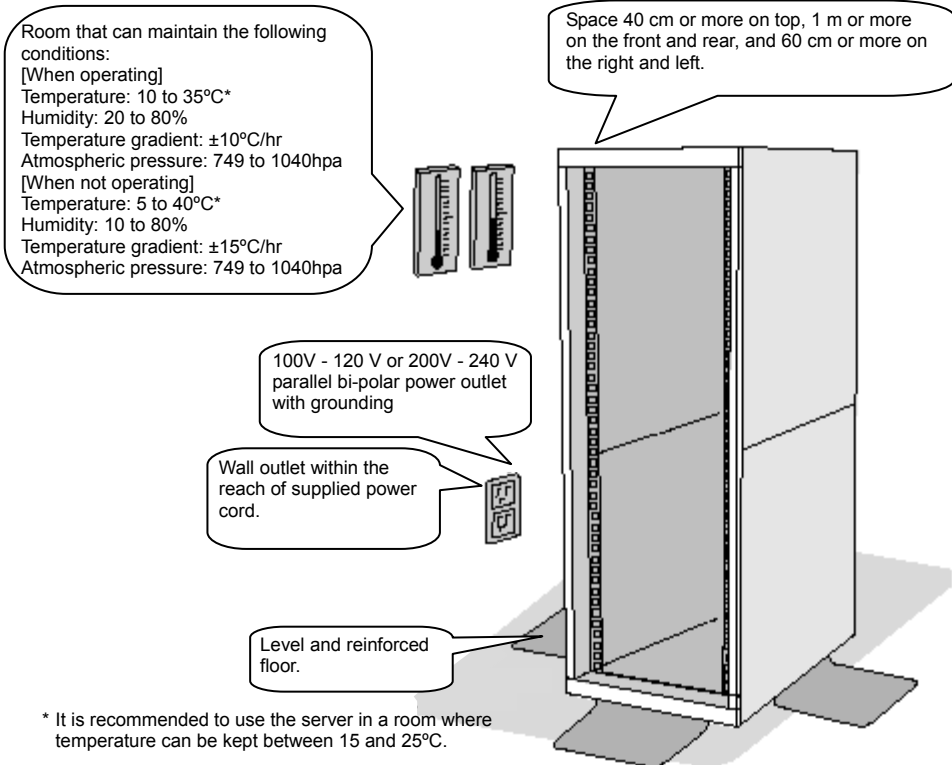

⚠ WARNING

Observe the following precautions to use the server safely. There is a risk of a death or serious injury. For details, see “NOTES FOR SAFE HANDLING” in Chapter 1.

- Do not install the server in non-designated places.
- Do not connect the ground wire to a gas pipe.

⚠ CAUTION

Observe the following precautions to use the server safely. There is a risk of a burn, personal injury, or damage to physical assets. For details, see “NOTES FOR SAFE HANDLING” in Chapter 1.

- Do not carry or install a rack alone.
- Do not install a rack in such a manner that its weight is imposed on a single place.
- Do not assemble or disassemble parts alone.
- Do not pull a device out of the rack if the rack is unstable.
- Do not leave more than one device pulled out from the rack.
- Do not install excessive wiring.

Do not install NEC Express5800/ft series in such places as listed below. If you locate racks or install the server in such places, the server may malfunction.

- Place where you cannot pull out the components fully.
- Place that cannot sustain the total weight of the rack and its components.
- Place where you cannot use stabilizers or where you cannot perform installation without quake-resistant engineering.
- Place whose floor is uneven or inclined.
- Place where temperatures change widely (near a heater, air conditioner, or refrigerator).
- Place that is subject to intense vibration.
- Place where corrosive gas (sodium chloride, sulfur dioxide, hydrogen sulfide, nitrogen dioxide, or ozone) is generated, or a place that is close to chemicals or exposed to chemicals.
- Place whose floor is covered with non-antistatic carpet.
- Place that may be subject to falling objects.
- Place that is close to some equipment that generates intense magnetic field (e.g., TV set, radio, broadcasting/communications antenna, power transmission wire, and electromagnetic crane). (If unavoidable, contact your sales agent to request proper shield construction.)
- Place where the power cords of the server must be connected to outlets that share the outlet of another device with large power consumption.

- Place that is close to some equipment that causes power noises (e.g., sparks caused by power-on/off using a relay). If you must install the server close to such equipment, request your sales agent for separate power cabling or noise filter installation.

IMPORTANT:

Temperature increase inside the rack and airflow.

If you install several components or the ventilation isn't good inside the rack, the internal temperature may increase due to heat emitted from the components. When the operating temperatures of NEC Express5800/ft series (10 to 35°C) are exceeded, there is a risk of malfunction. You must take adequate precautions and measures for airflow inside the rack as well as in the room so that the internal temperature can be kept within this range during operation.

Connection

Connect peripheral devices to NEC Express5800/ft series.

The server is provided with connectors for wide variety of peripheral devices on its front and rear. The figure on the next page illustrates available peripheral devices for the server in the standard configuration, and locations of the connectors for the devices. After connecting the peripheral devices, connect the provided power cords with the server, and then plug the power cords into the power outlet.

WARNING



Observe the following precautions to use the server safely. There is a risk of a death or serious injury. For details, see “NOTES FOR SAFE HANDLING” in Chapter 1.

- Do not hold the power plug with a wet hand.
- Do not connect the ground wire to a gas pipe.

CAUTION



Observe the following precautions instructions to use the equipment safely. There is a risk of a burn, personal injury, or damage to physical assets. For details, see “NOTES FOR SAFE HANDLING” in Chapter 1.

- Do not plug the power cord in a nonconforming outlet.
- Do not plug too many cords in a single outlet.
- Do not plug the cord insecurely.
- Do not use nonconforming power cords.

IMPORTANT:

- Power off the server before connecting peripheral devices, with the exception of peripherals with USB interface. Connecting a powered peripheral device to the powered server will cause malfunctions and failures.
 - To connect a third-party peripheral device or interface cable to the server, check with your sales agent to see if they are compatible with NEC Express5800/ft series. Some third-party devices may not be used with the server.
 - The total cable length of SCSI device connections is up to 6 m, including the internal SCSI cables.
 - The serial port connectors are reserved for maintenance.
 - Place the USB floppy disk drive on the server. Space of 1U is needed to put it on the server.
-

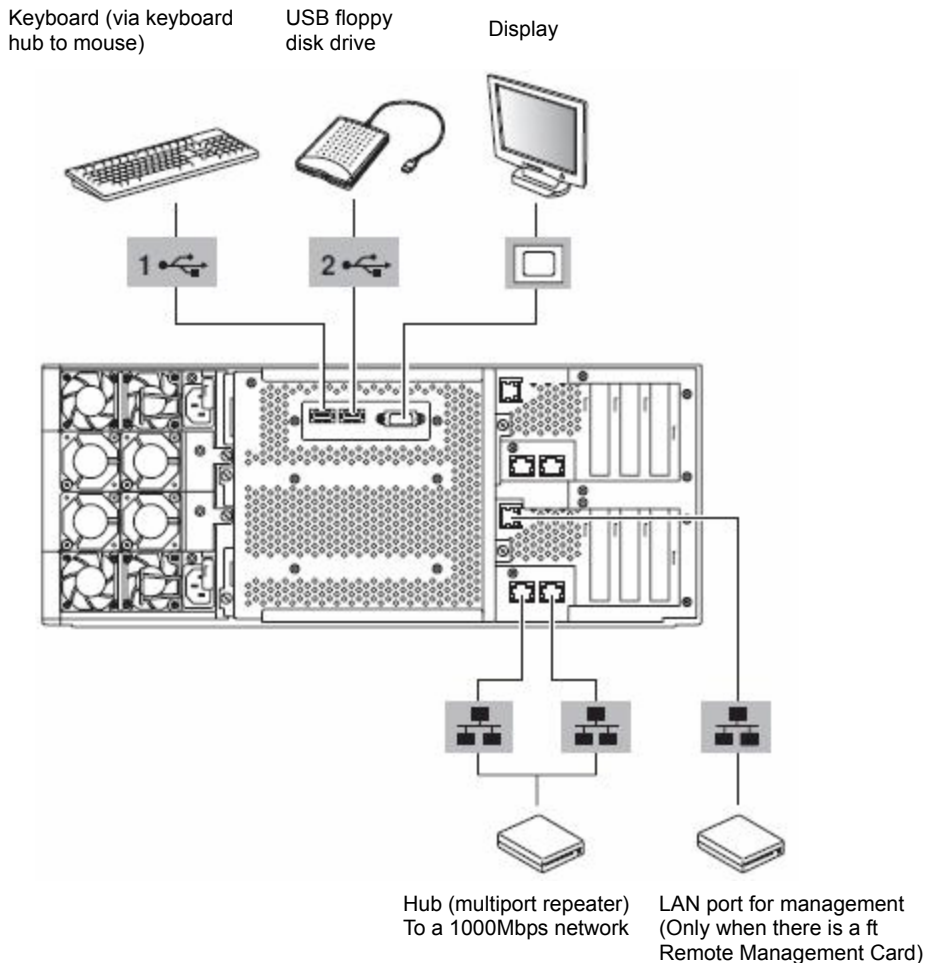

IMPORTANT:

Connection of optional devices

- In the case of standard configuration, you need to complete setup of the operating system before mounting optional PCI cards or hard disks that you purchased separately.
 - If N8803-033 is mounted, be sure to connect cables to the FC array unit before going on to the next step.
-

Insert the power cords to the AC inlets of the power unit.

Then, secure the power cords using the locking springs on the power units.

When completing connection to peripheral equipment, connect the two provided power cords to the server. After that, secure the cables with the cable tie provided in the server.

Connect the plug at the other end of the power cord to a wall outlet with parallel double-pole grounds provided or to an uninterruptible power supply (UPS).

To use the functions of the server, you should connect the server to the UPS.

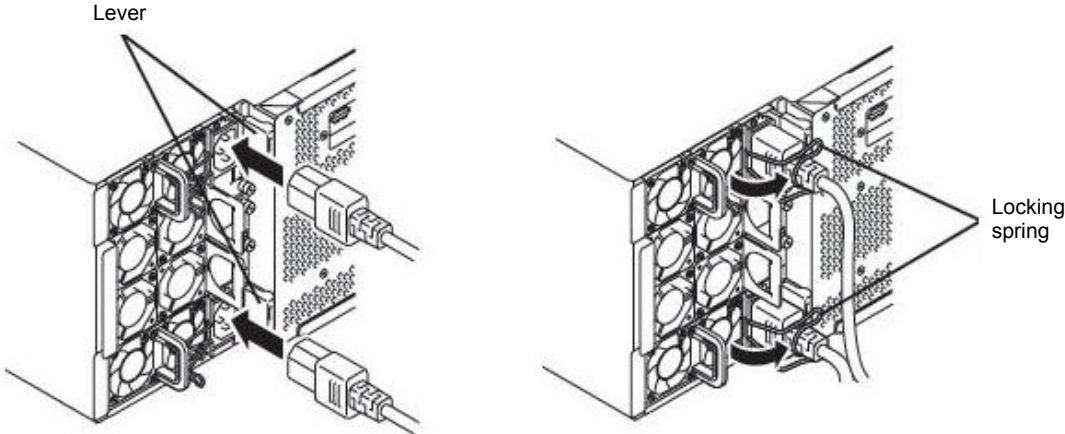

IMPORTANT:

- Be sure to use both of the power cords to make the server fault-tolerant.
 - After connecting the power cords, wait at least 30 seconds before pressing the power switch.
-

To connect the power cords from the server to an uninterruptible power supply (UPS), use service outlets on the rear of the UPS.

The UPS service outlets are categorized into two groups: SWITCH OUT and UN-SWITCH OUT. (They may be called "OUTPUT1" and "OUTPUT2.")

For constant power supply, connect the power cords to a UN-SWITCH OUT outlet. (Connect the modem that is in service for 24 hours to this outlet.)

When the power cords from the server are connected to a UPS, change the BIOS setup of the server to link with power supply from the UPS.

Select [AC-LINK] from [Server] on the BIOS setup utility and change parameters. See the separate volume of User's Guide for details.

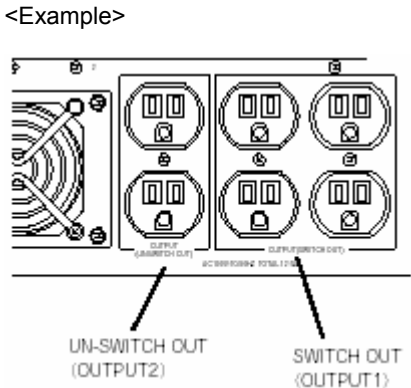

(This page is intentionally left blank.)

Chapter 4

Linux Setup

This chapter describes procedures for setup to power on the NEC Express5800/ft series for the first time, installation of Linux, setup of dual configuration of LAN cards, setup of dual disk configuration and so on.

SETUP FLOW

The following flow-chart illustrates the flow of the setup procedures for the server.

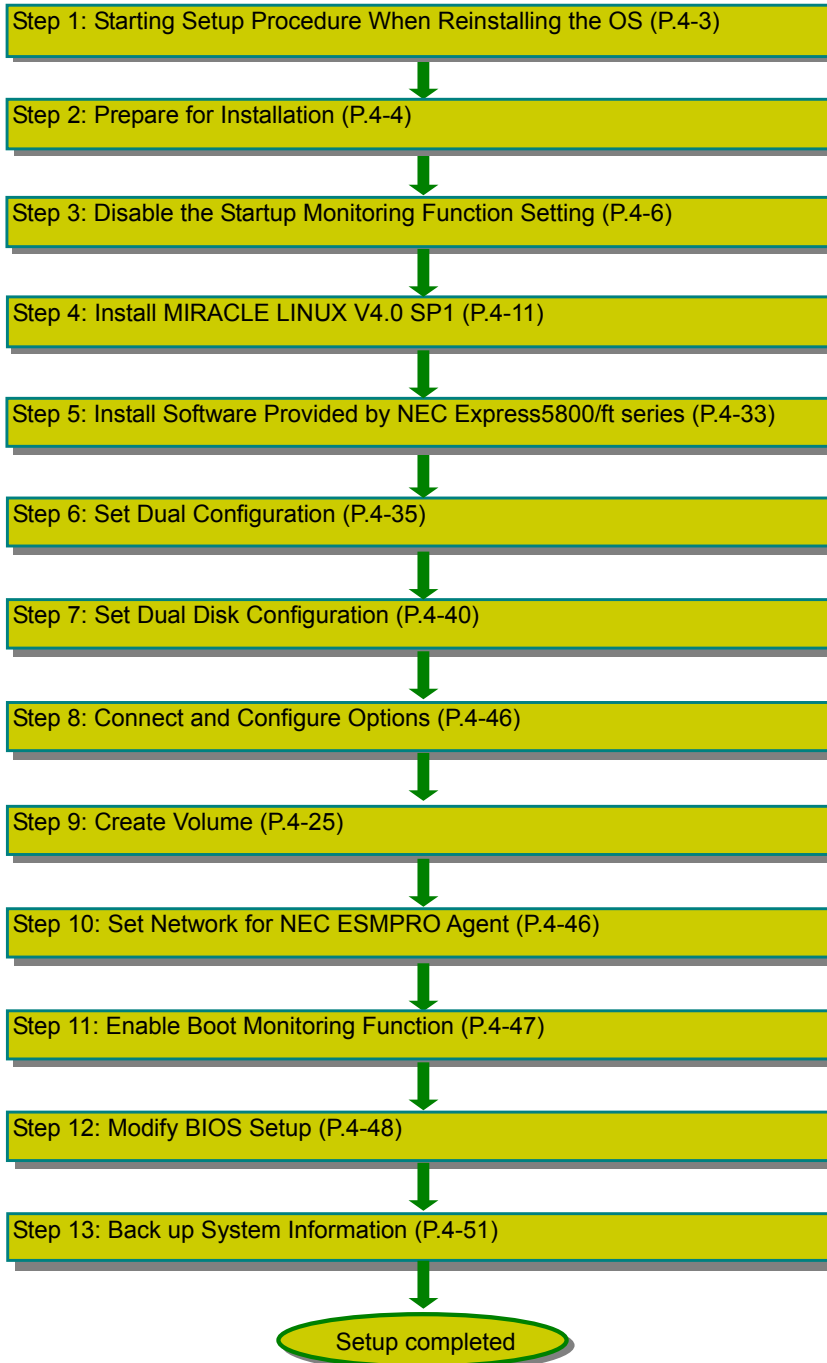

SETUP PROCEDURE

You can set up the NEC Express5800/ft series again using a backup CD-ROM.

IMPORTANT:

- The NEC Express5800/ft series is a precision instrument. Ask maintenance personnel with technical knowledge to install it.
-

The following is the procedure to reinstall the OS.

Step 1: Starting Setup Procedure When Reinstalling the OS

The following explains the reinstallation procedure of the OS.
You need the following to install MIRACLE LINUX V4.0 SP1.

- MIRACLE LINUX V4.0 Install CD (1 of 2)
- MIRACLE LINUX V4.0 Install CD (2 of 2)
- MIRACLE LINUX V4.0 SP1 Install CD (1 of 2)
- MIRACLE LINUX V4.0 SP1 Install CD (2 of 2)
- NEC EXPRESSBUILDER CD
- User's Guide (Setup) (this manual)
- User's Guide

Step 2: Prepare for Installation

Before starting MIRACLE LINUX V4.0 SP1 installation, be sure to do the following. If these preparations are not performed, setup cannot be performed properly.

Prepare NEC Express5800/ft series

With the power of NEC Express5800/ft series off, follow the steps below:

1. Prepare NEC Express5800/ft series.

Perform the following preparations.

- Remove all optional PCI boards and peripheral devices.
- Remove all LAN cables.

2. Make the CPU/IO module #0 primary.

The location of the parts required for operation and confirmation are shown below.

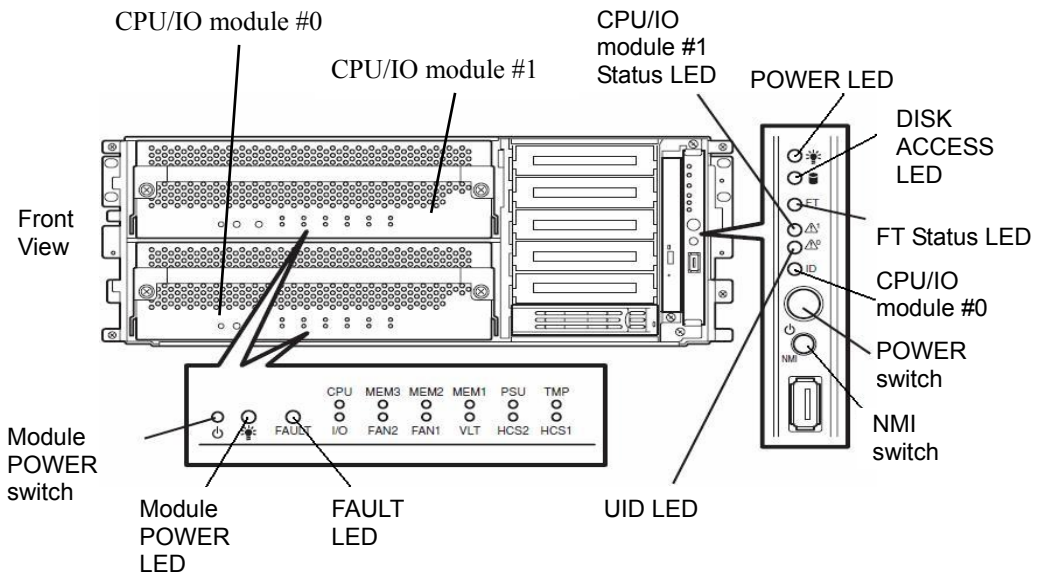

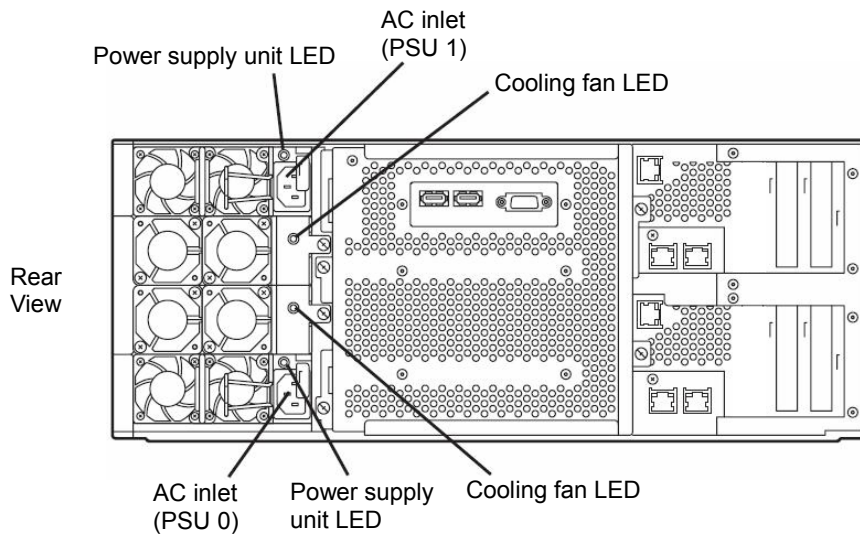

<When the AC power is off (The power cords are not plugged into the outlet)>

Connect the power cords to NEC Express5800/ft series in the following order:

- (1) Connect the power cord to the AC inlet B (PSU 0)
- (2) Connect the power cord to the AC inlet A (PSU 1)
- (3) Confirm that the power supply unit LEDs are illuminated.

Preparation is now completed. Start the installation of MIRACLE LINUX V4.0 SP1.

<When the AC power is on (The power cord is plugged to the wall outlet and the main unit's power is off)>

- (1) Check the LED of the power supply units.
 - When both PSU 0 and PSU 1 LEDs are on:
 - a) Remove the AC cable of PSU 1.
 - b) Wait for 30 seconds or longer and then reconnect the AC cable.
 - c) Confirm that the power supply unit LED of PSU 1 is on.
 - When either PSU 0 or PSU 1 LED is on:
 - a) Remove the AC cables of PSU 0 and PSU 1.
 - b) Wait for 30 seconds or longer and then reconnect the AC cable of PSU 0.
 - c) Confirm that the power supply unit LED of PSU 0 is on. Then, reconnect the AC cable of PSU 1.
 - d) Confirm that the power supply unit LED of PSU 1 is on.

Preparation is now completed. Start the installation of MIRACLE LINUX V4.0 SP1.

Step 3: Disable the Startup Monitoring Function Setting

Check whether the power is ON and make settings for properly performing setup for later on.

This equipment has a function to monitor the main unit at startup. (Enabled in the configuration at shipment)

When reinstalling the operating system, this monitoring function needs to be disabled. Otherwise the installation may not be done properly. Follow the steps in this section and make proper settings.

IMPORTANT:

If you skip the settings described here, the system will be restarted forcefully while the OS setup screen is shown and the setup will be unsuccessful; BIOS may repeat the OS setup in an invalid manner. In this case, you will need to restart the setup procedures from the beginning.

TIPS:

For details of operations for BIOS Setup Utility and parameters, see the separate volume of User's Guide.

<Procedure for Changing BIOS settings>

1. Turn on the display and the peripheral equipment connected to the NEC Express5800/ft series.

CHECK:

If the power cords are connected to a power controller like a UPS, make sure that it is powered on.

2. Detach the front bezel in case of a rack-mount model (or open it in the case of a tower model).

3. Press the POWER switch which is located on the front side of the server.

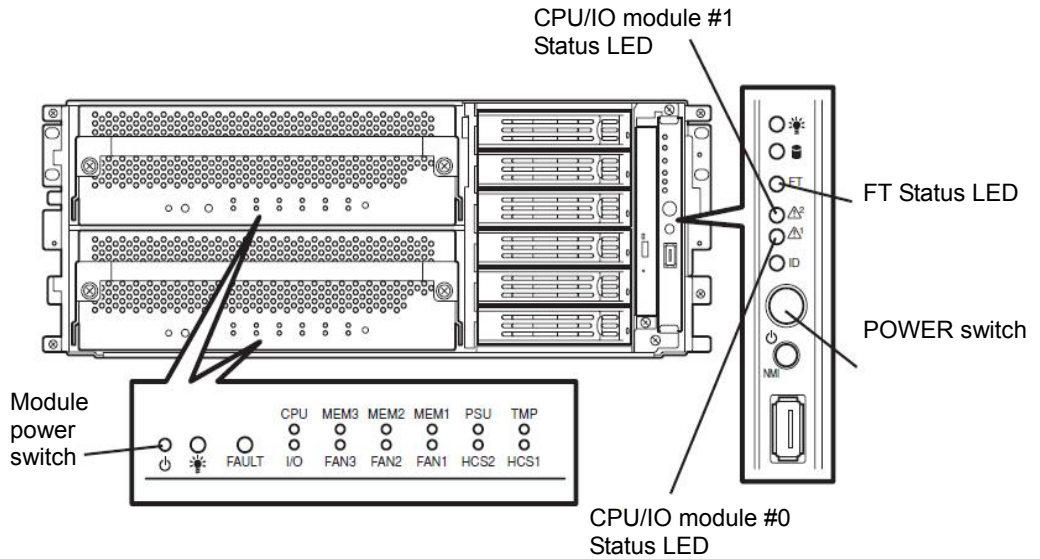

IMPORTANT:

Do not turn off the power before the "NEC" logo appears.

After a while, the "NEC" logo will appear on the screen.

While the "NEC" logo is displayed on the screen, NEC Express5800/ft series is performing a power-on self test (POST) to check itself. For details, see the separate volume of User's Guide.

CHECK:

If the server finds errors during POST, it will interrupt POST and display the error message. See the separate volume of User's Guide.

- When the message “Press <F2> to enter SETUP” or “Press <F2> to enter SETUP or Press <F12> to boot from Network” on the display screen, press **F2**.

The BIOS Setup Utility “SETUP” starts and the Main menu is displayed on the screen.

<Example>

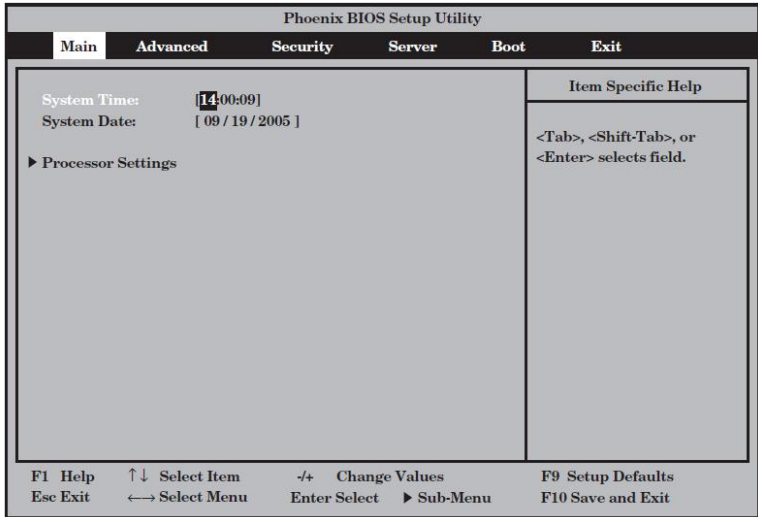

- Move the cursor onto "Server" and select “Server.”

The Server menu will be displayed.

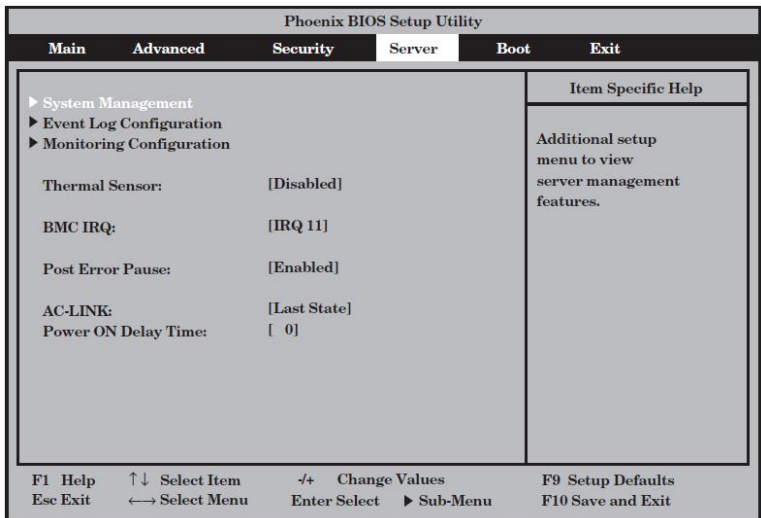

6. Move the cursor onto “Monitoring Configuration” and press **Enter**.

The Monitoring Configuration submenu appears.

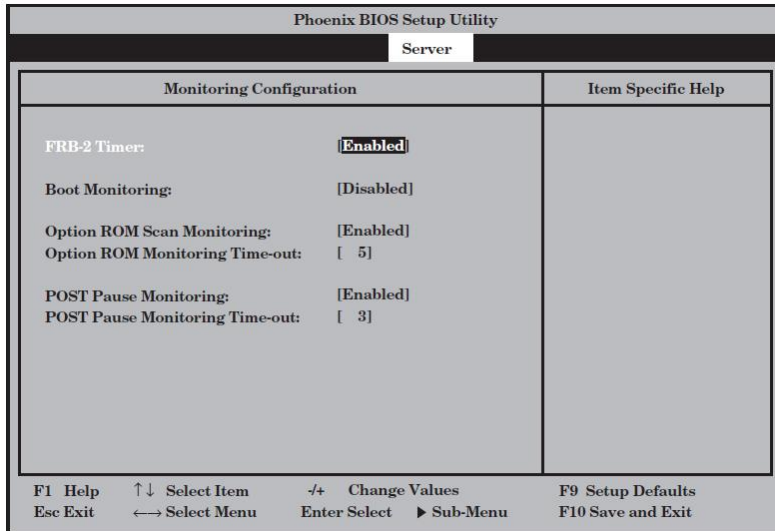

7. Move the cursor onto “Boot Monitoring” and press **Enter**.

Parameters will be displayed.

8. Among the parameters, choose “Disabled” and press **Enter**.

The current display of the configuration for Boot Monitoring will be changed to “Disabled.”

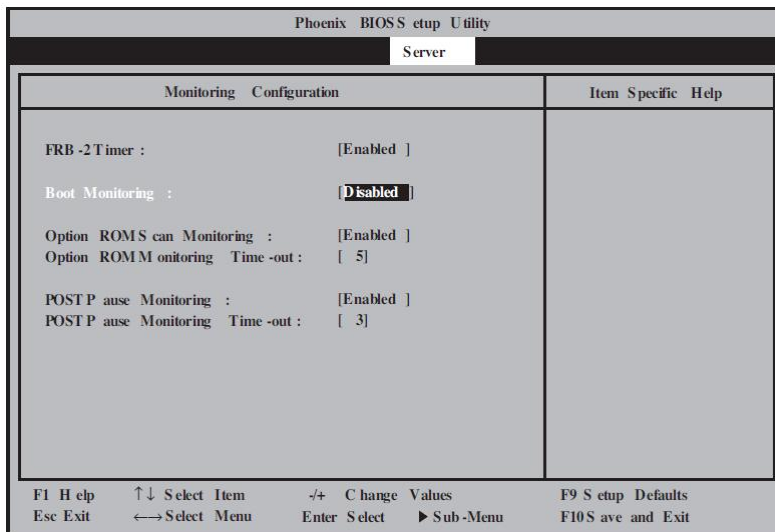

9. Press **Esc** twice to go back to the Advanced menu, and then move the cursor onto "Exit" to display the Exit menu.

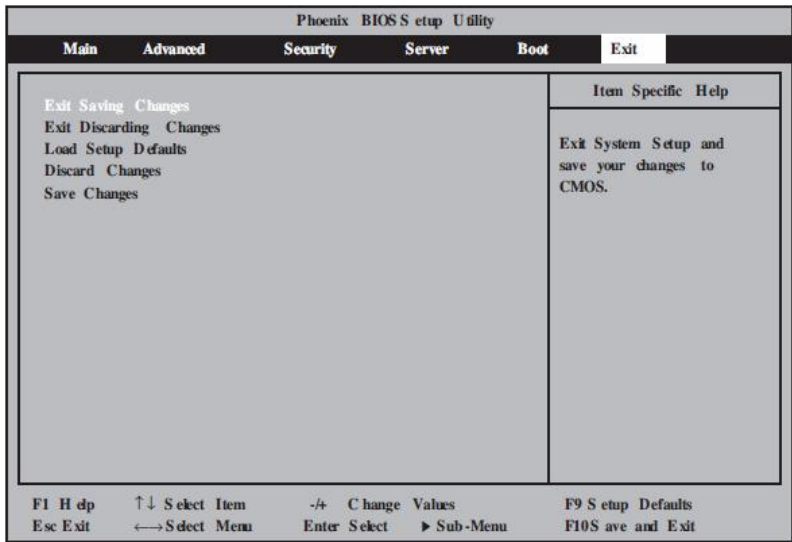

10. Move the cursor onto "Exit Saving Changes" and press **Enter**.
The confirmation window will appear.

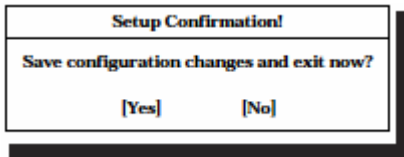

11. Select "Yes" and press **Enter**.
After the configuration data is saved and SETUP is terminated, the system is rebooted. This is the end of steps for switching boot monitoring function.

TIPS:

When reinstalling the OS, power off this server to prepare for reinstallation. Then, referring to "Step 4: Install MIRACLE LINUX V4.0 SP1" on the next page, continue the setup.

Step 4: Install MIRACLE LINUX V4.0 SP1

With NEC Express5800/ft series, configure RAID1 with all built-in disks by using software. Make pairs of hard disk drives in Slot0 with Slot3, Slot1 with Slot4, and Slot2 with Slot5.

Configure Slot0 and Slot3 as the boot disks, and then follow the procedure below to install MIRACLE LINUX V4.0 SP1.

1. Power on the NEC Express5800/ft series.
2. Insert the installation CD (1 of 2) into the CD-ROM drive of the server.
3. Reset the system (press **Ctrl**, **Alt** and **Delete** together) or turn the power off and then on to restart the NEC Express5800/ft series.

When the NEC Express5800/ft series is restarted, the main menu is displayed.
Press **Enter** to start the installation in the graphical mode.

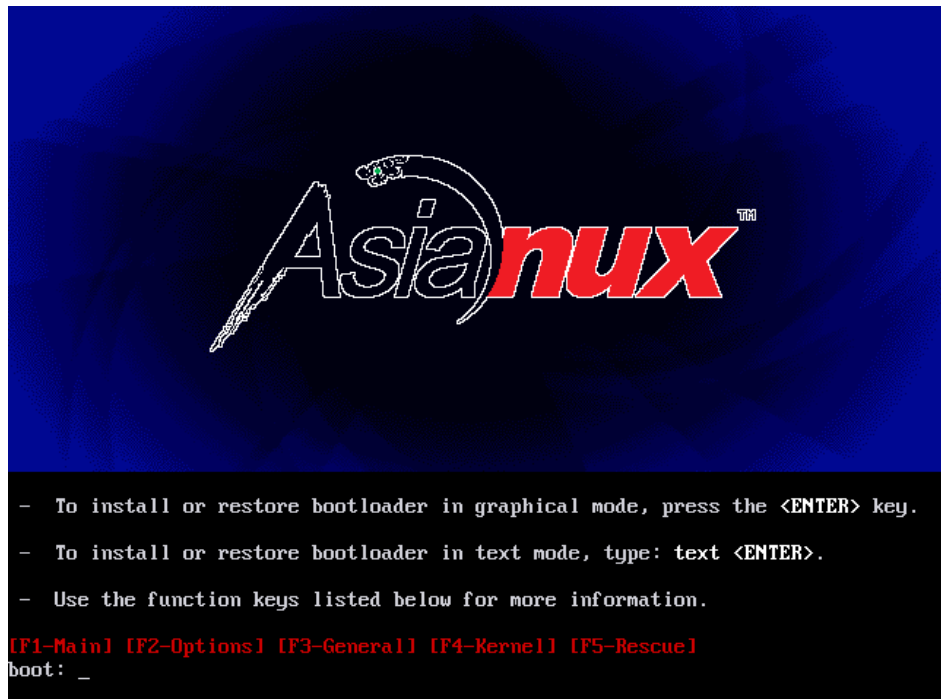

The installer starts in the graphical mode.
Click **Next** to continue.



The screen for selecting a language is displayed.
Select “English (English)” to display messages in English.
Click **Next** to proceed.

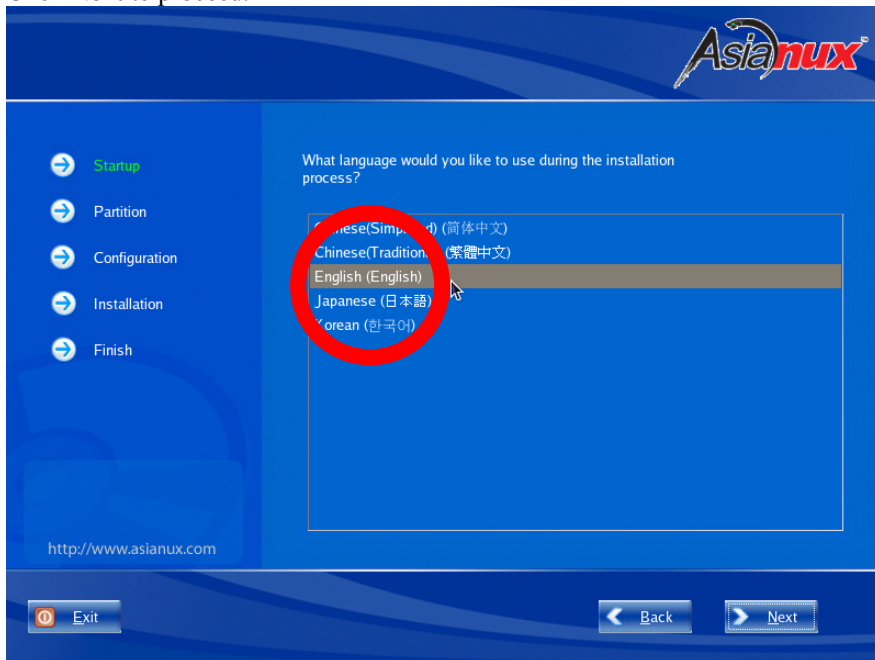

Follow the instruction on the screen, and if you agree, select **Accept**.
Click **Next** to proceed.

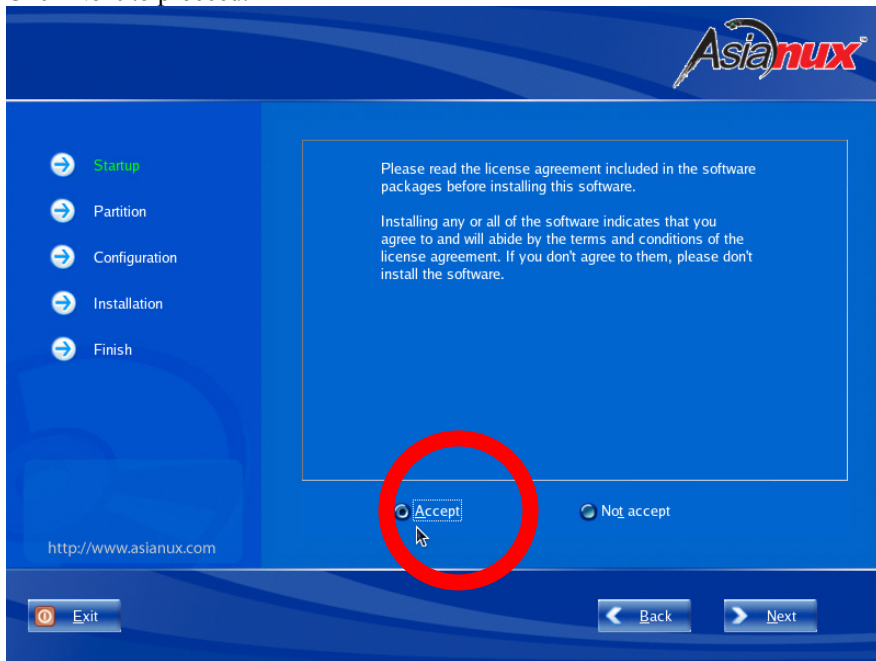

Select an appropriate keyboard.
Click **Next** to proceed.

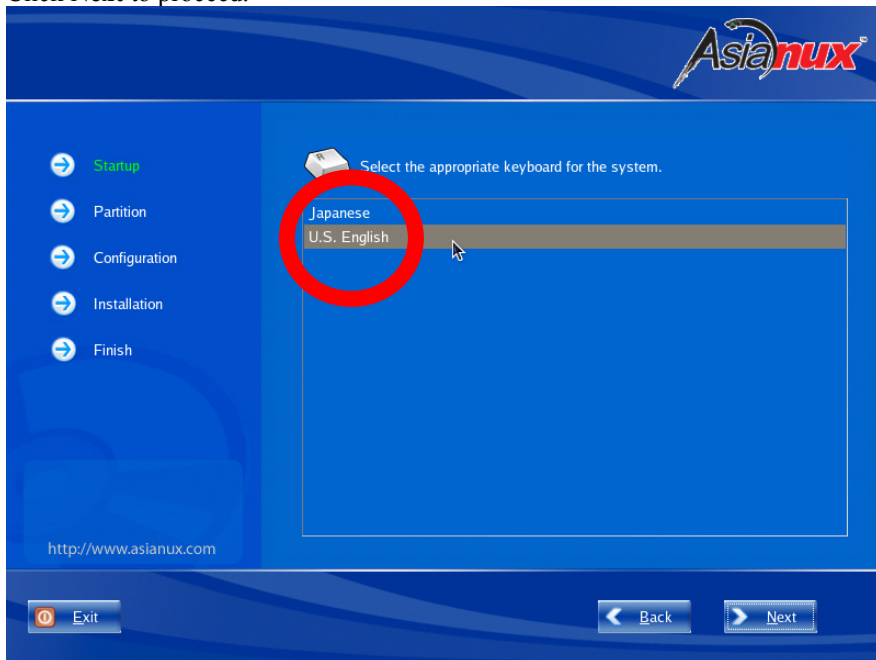

Partition configuration for the NEC Express5800/ft series is required. Select “Manually partition with Disk Druid.”

Click **Next** to proceed.

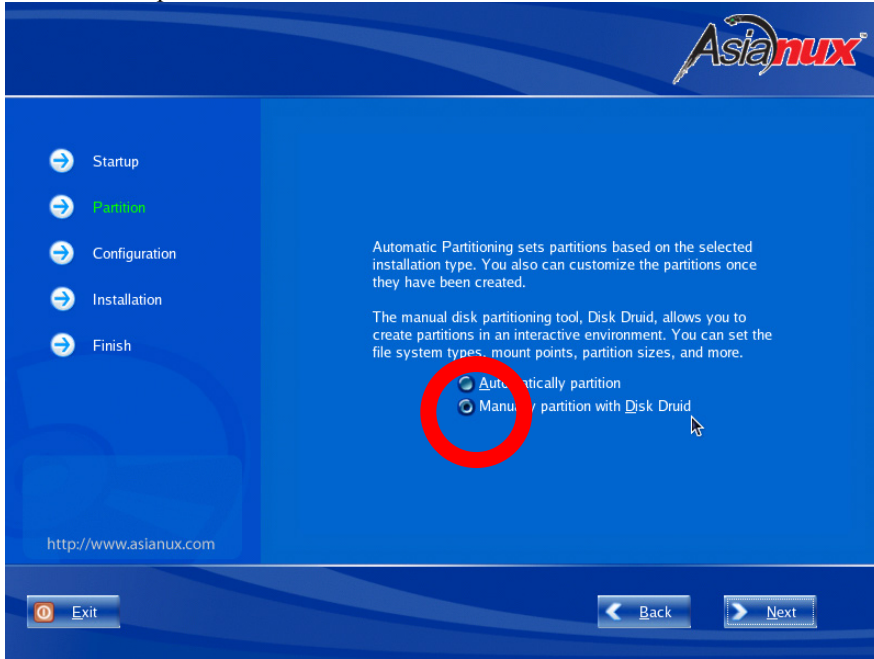

Warning messages may be displayed., Click **Yes** to continue unless there is a problem.

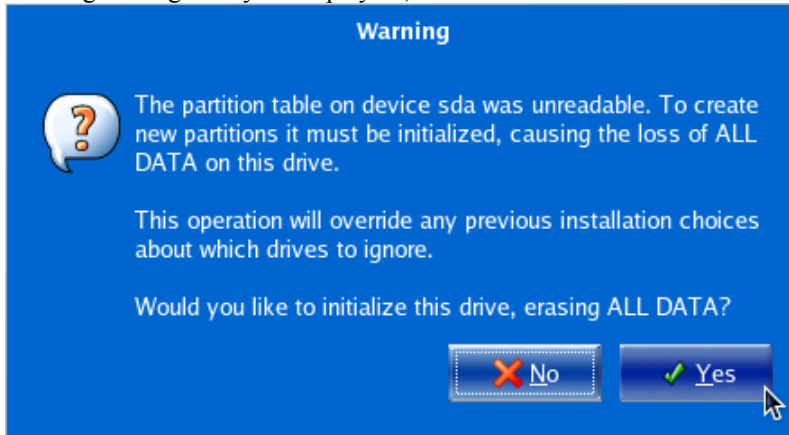

CHECK:

Device names vary depending on the number of mounted hard disk drives. Check the device name of each hard disk drive.

Number of disks Slot number	Device ID		
	2	4	6
Slot 5	-	-	sdf
Slot 4	-	sdd	sde
Slot 3	sdb	sdc	sdd
Slot 2	-	-	sdc
Slot 1	-	sdb	sdb
Slot 0	sda	sda	sda

IMPORTANT:

Software RAID disks need to be paired by matching slot numbers as shown below.

- Slot 0 and Slot 3
- Slot 1 and Slot 4
- Slot 2 and Slot 5

IMPORTANT:

- Configure software RAID (level=1, number of disks=2, number of spares=0) to all partitions except the dump partition.
- /boot must be associated with /dev/md0.
- Create a dump partition for each of the paired disks (total of two dump partitions). For the size of the dump partitions, allocate the memory size multiplied by 1.05.
- LVM cannot be used.
- Because the partition including /var stores dump files, plenty of available space is required. (The dump file is stored under /var/crash. The maximum size of the dump file is about “the mounted memory size + 1.5GB.”)

Example of partition configuration [Number of disks: 2 (Mounted to Slot 0 and Slot 3)]				
Partition to add	Mount point	File system	Device used	Capacity
/boot partition	/boot	ext3	md0 (sda1+sdb1)	200MB
/ partition	/	ext3	md1 (sda2+sdb2)	20GB
swap partition	-	swap	md2 (sda3+sdb3)	Mounted memory size ×2
dump partition 1	-	Diskdump Partition	sda5	Mounted memory size ×1.05
dump partition 2	-	Diskdump Partition	sdb5	Mounted memory size ×1.05
/var partition	/var	ext3	md3 (sda6+sdb6)	The rest

- Creating a RAID device (md device)

Click **RAID**.

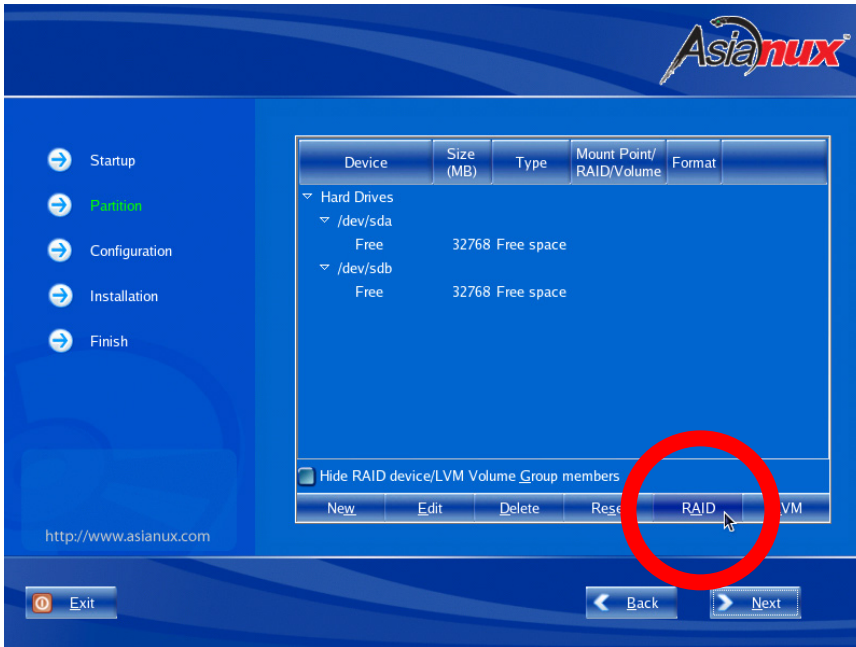

Select “Create a software RAID partition.”
Click **OK** to proceed.

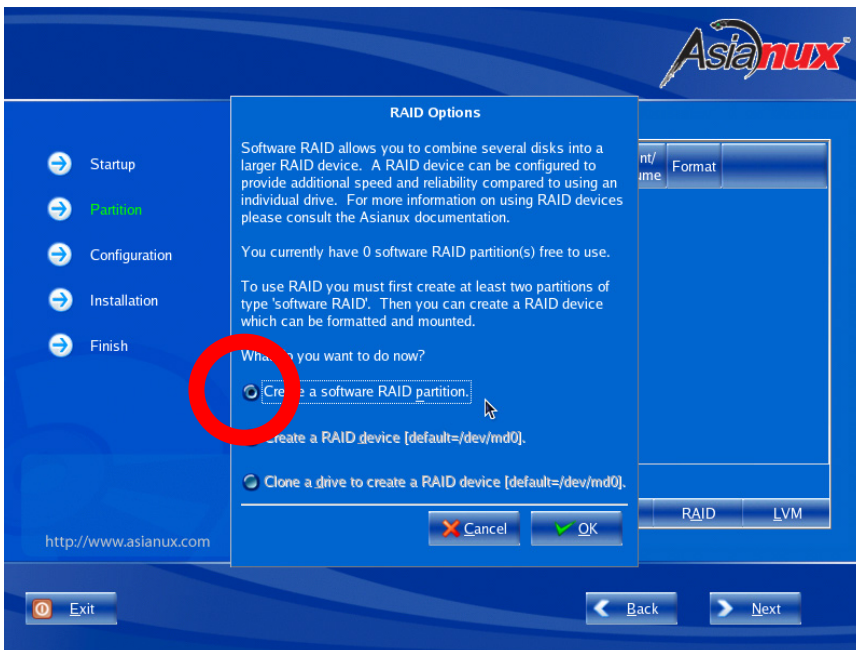

Choose a drive to use and type its size.
Click **OK** to add the partition.

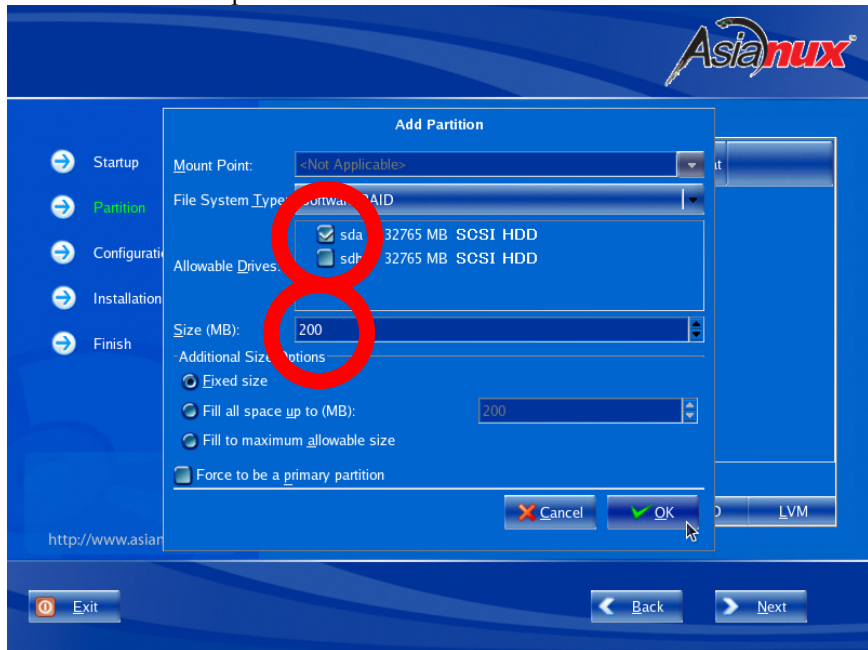

Add a partition for other drive in the same manner.
Specify the same size as the one you just added.

Confirm that two software RAID partitions are created.
Click **RAID** to create a RAID device.

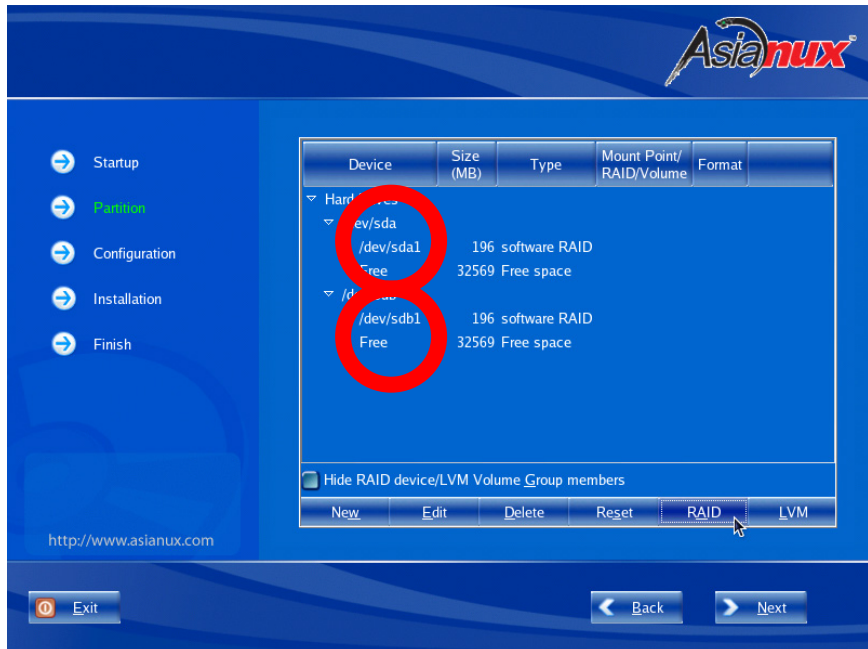

Select “Create a RAID device [default=/dev/md0].”
Click **OK** to proceed.

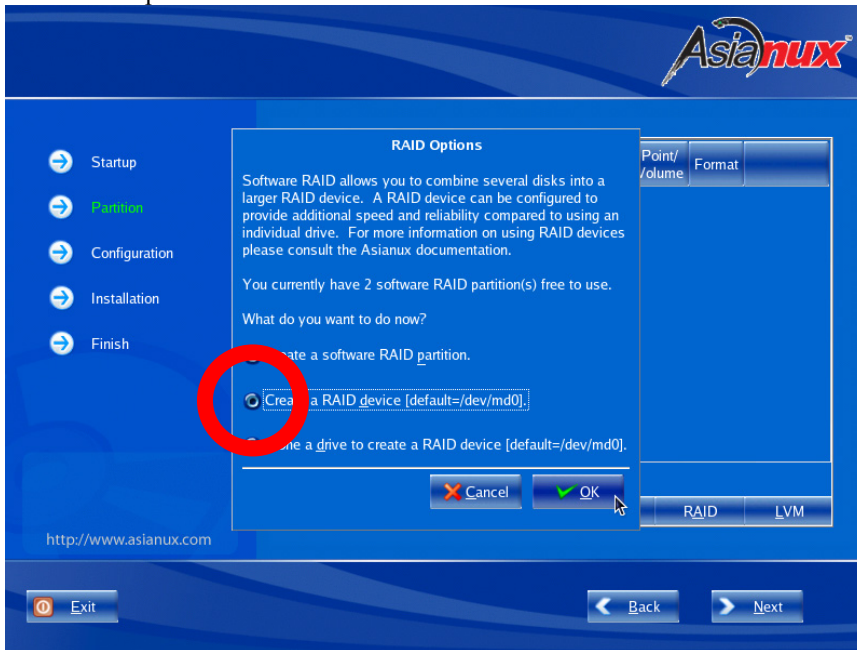

Specify the mount point and the file system type (for a swap partition, select “swap”).
Specify /boot as the mount point of the RAID device md0. (md0 is mandatory.)
Set the RAID level to RAID1.
Check the RAID members.
Note: Spares cannot be set. (Specify 0 to the number of spares.)

If there is no problem with the setting items, click **OK** to create a RAID device.

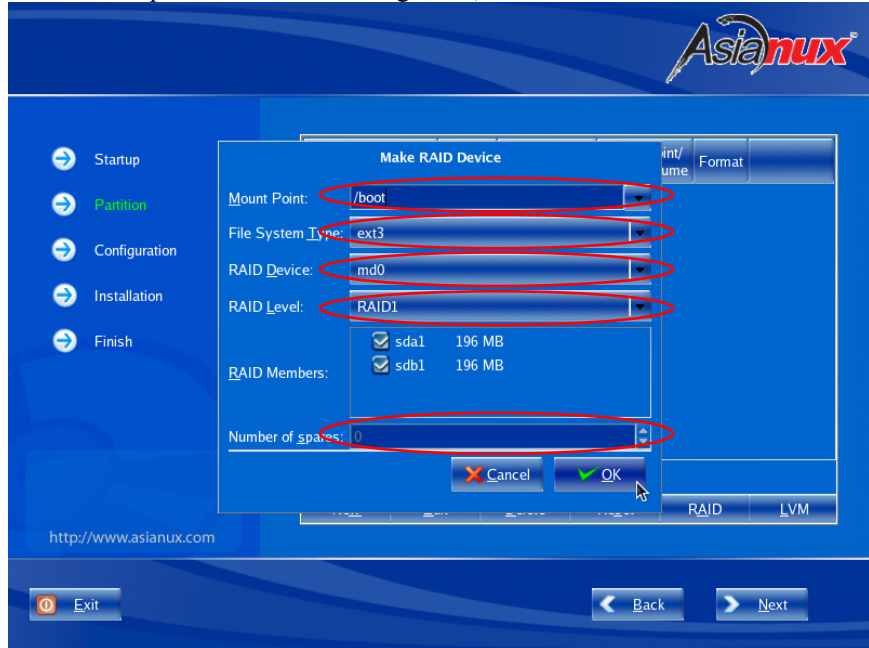

Confirm that the RAID device is created.

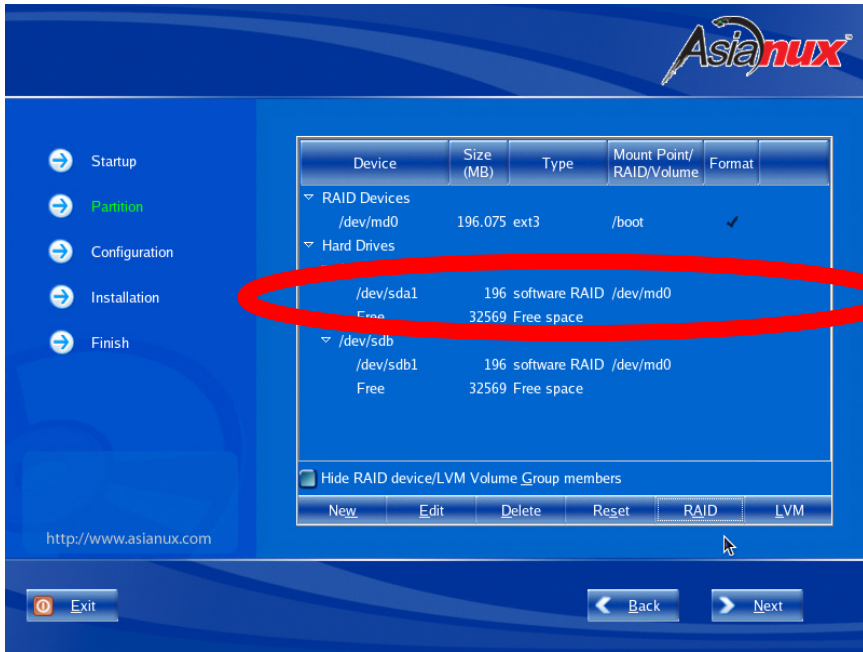

Repeat the same procedure to create required RAID devices.

- Creating a dump partition
Click **New**.

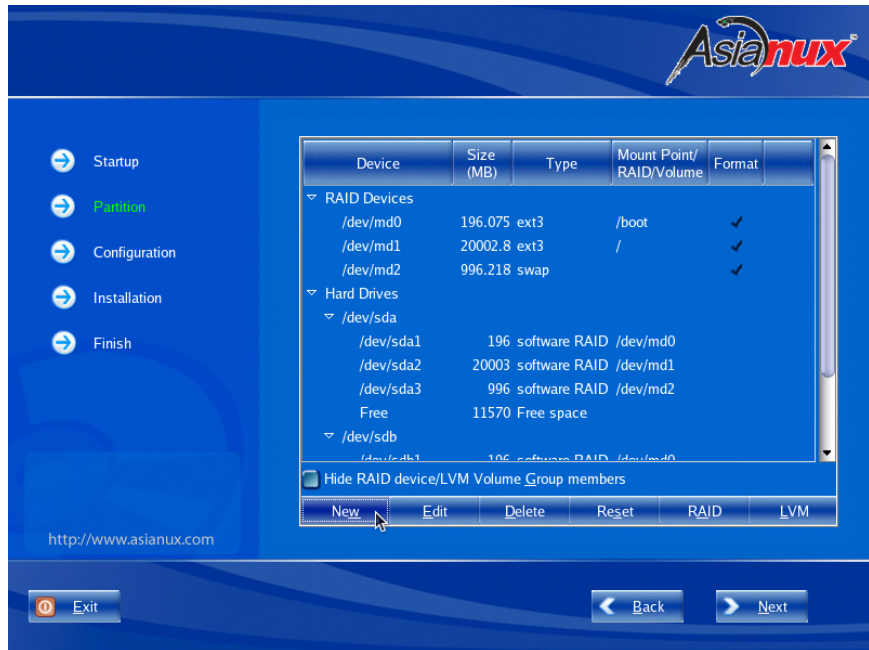

- Select “Diskdump Partition” for the file system type.
- Select a drive.
- Specify the mounted memory size multiplied by 1.05 as the size.
- If there is no problem, click **OK** to create a dump partition.

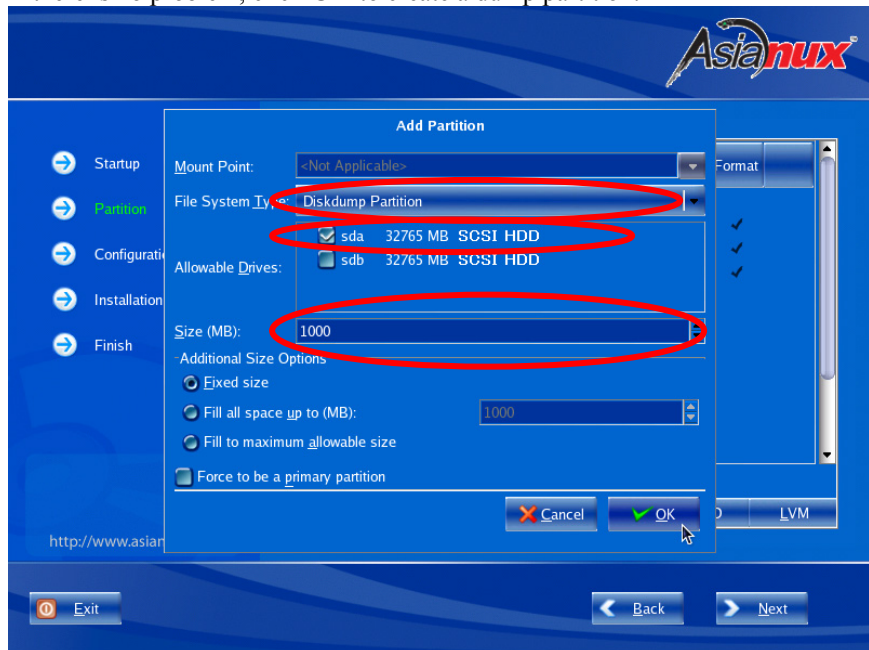

Confirm that the dump partition is created.

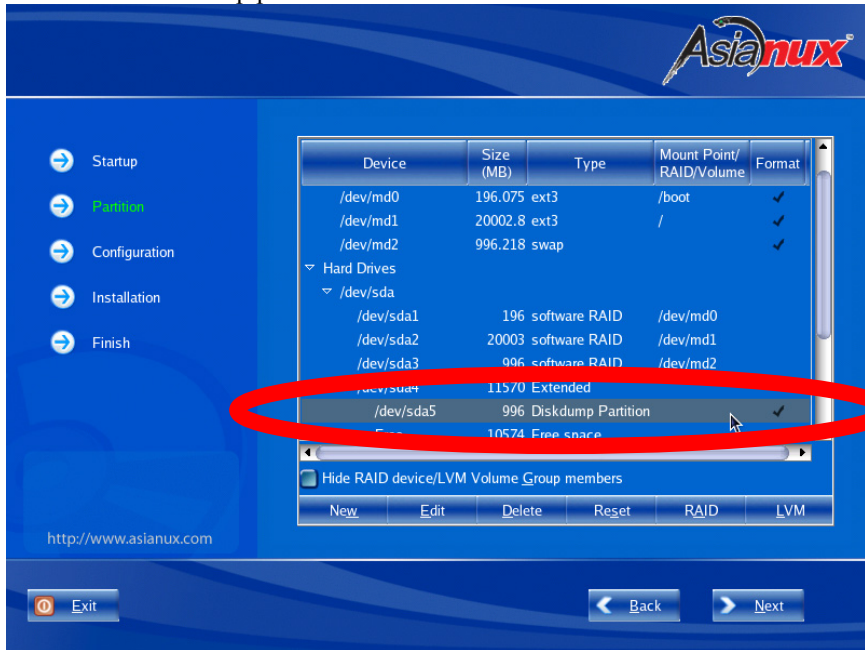

Repeat the same procedure to create a dump partition for the other drive.

Confirm that all necessary partitions are created.

If not, repeat the above procedure to create required partitions.

Click **Next** to proceed if there is no problem.



No special setting is required.
Do not change the installation location of a boot loader.
Configure settings such as a boot loader password as necessary.
Click **Next** to proceed.

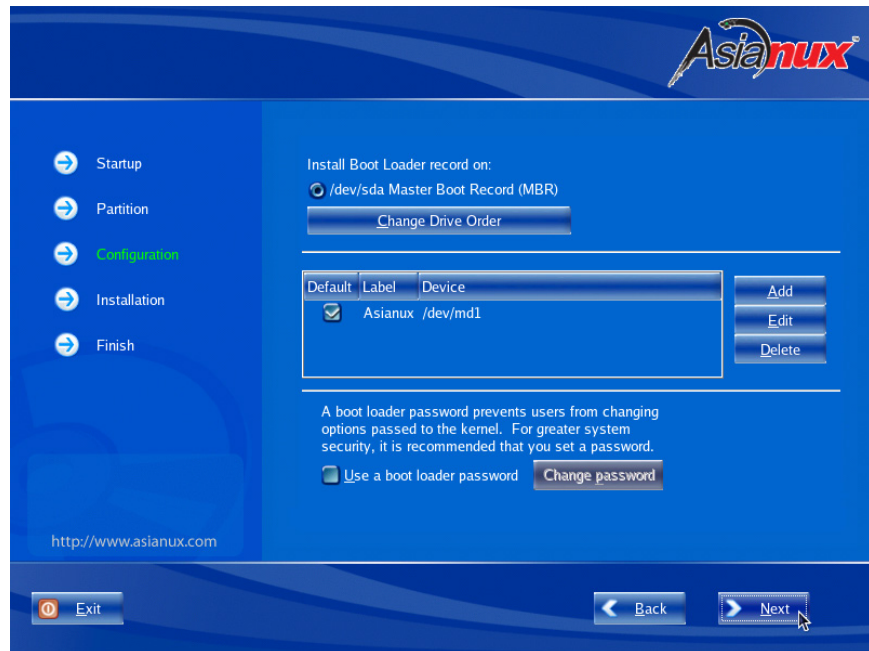

CHECK:

About boot loader

- NEC Express5800/ft series only supports Grub.
 - A boot loader is installed on the disk mounted to Slot 0, but it is also installed on the disk mounted to Slot 3 after the completion of GeminiEngine Control Software installation. Therefore, if the server cannot boot from the disk in Slot 0 due to some failure, the disk in Slot 3 can be mounted to Slot 0 to boot from there.
-

Network settings do not need to be configured.

After the installation of GeminiEngine Control Software is completed, refer to “Step 6: Set Dual Configuration of LAN Cards” and configure settings of the network.

Click **Next** to proceed.

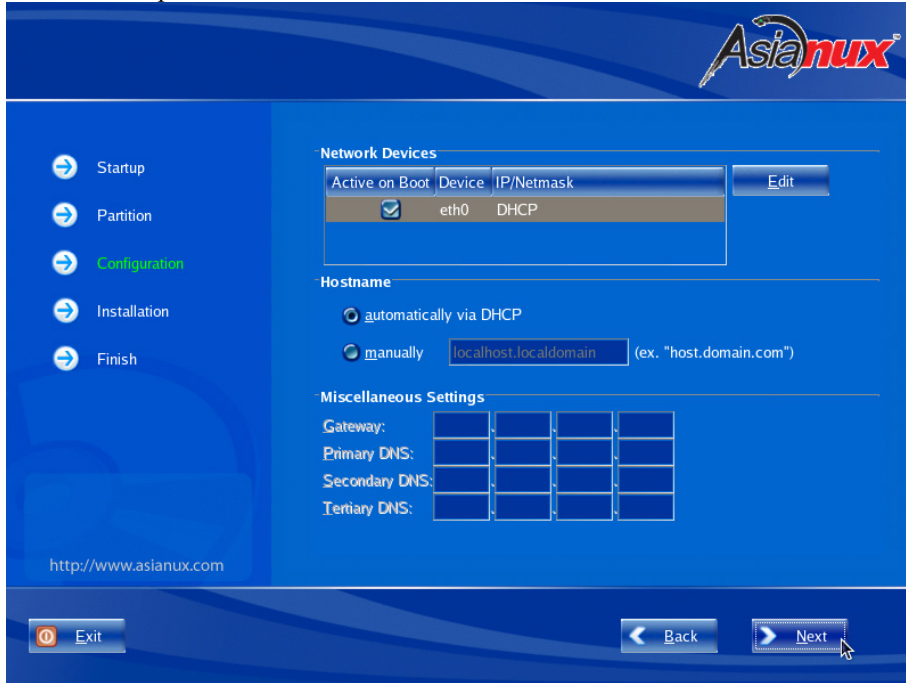

Change the time zone and system clock as necessary.
Click **Next** to proceed.

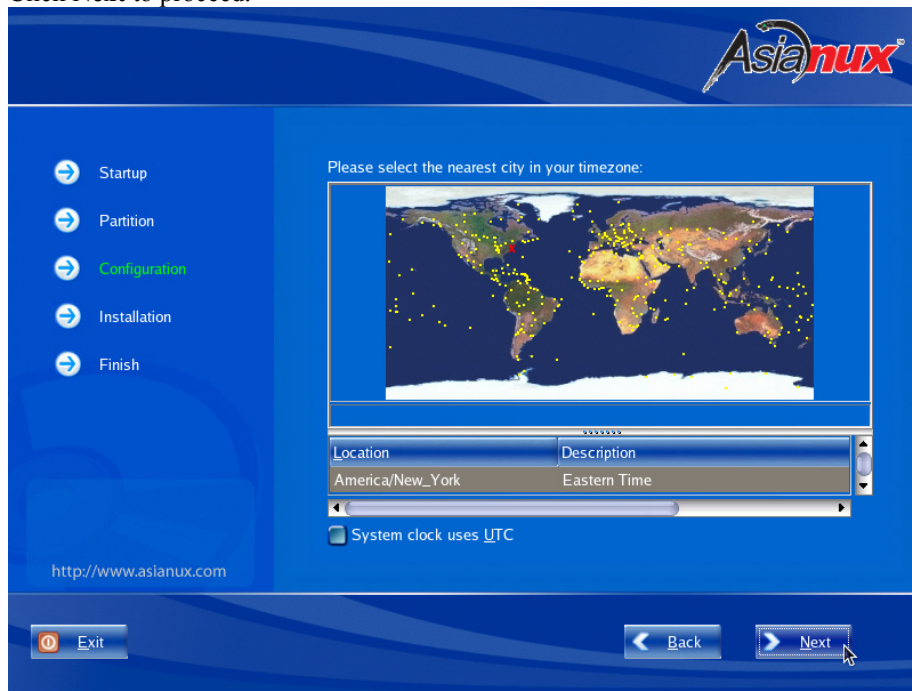

Set the password for root.
Click **Next** to proceed.

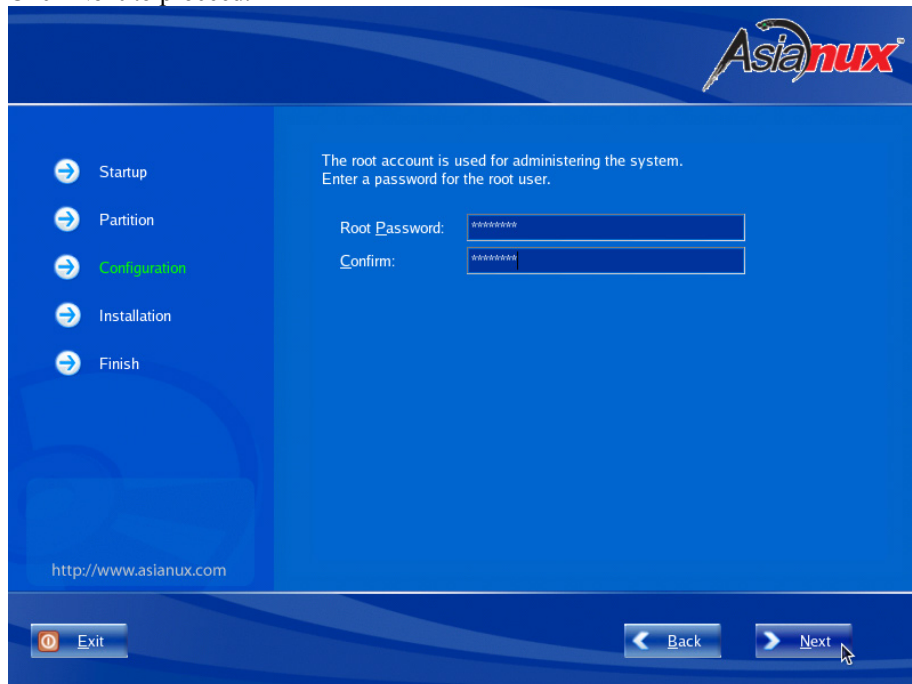

Select “All” for the installation type.
Click Next to proceed.

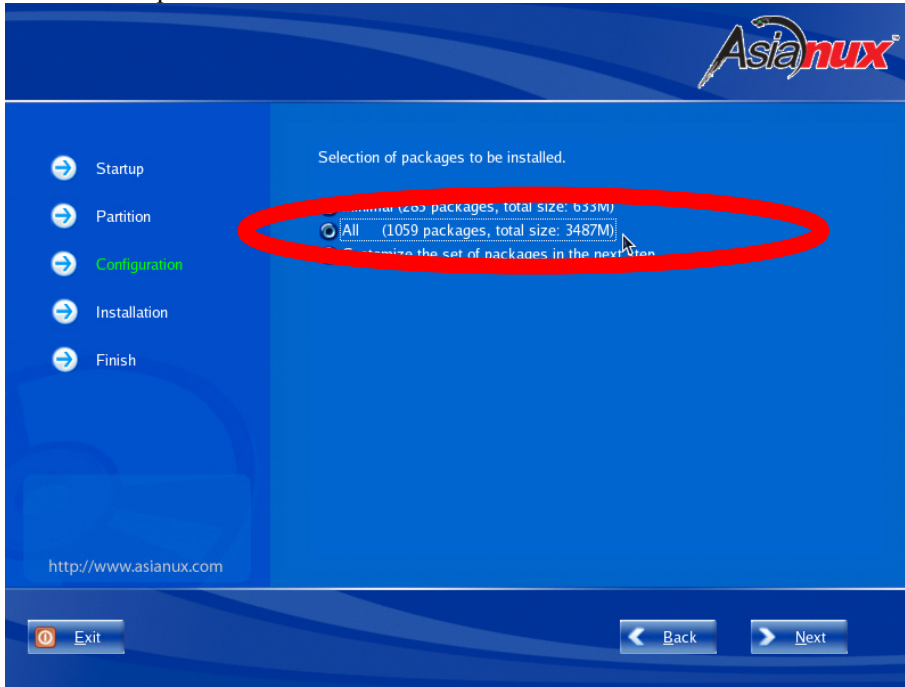

Click Next to start the installation.

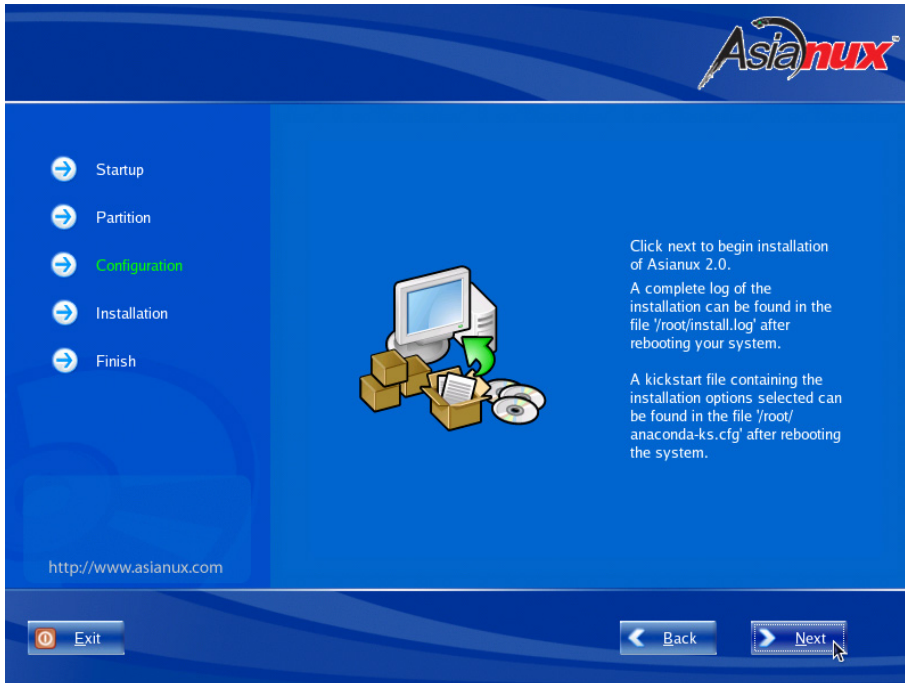

The color quality and screen resolution do not need to be changed.

Select a login type.
Click **Next** to proceed.

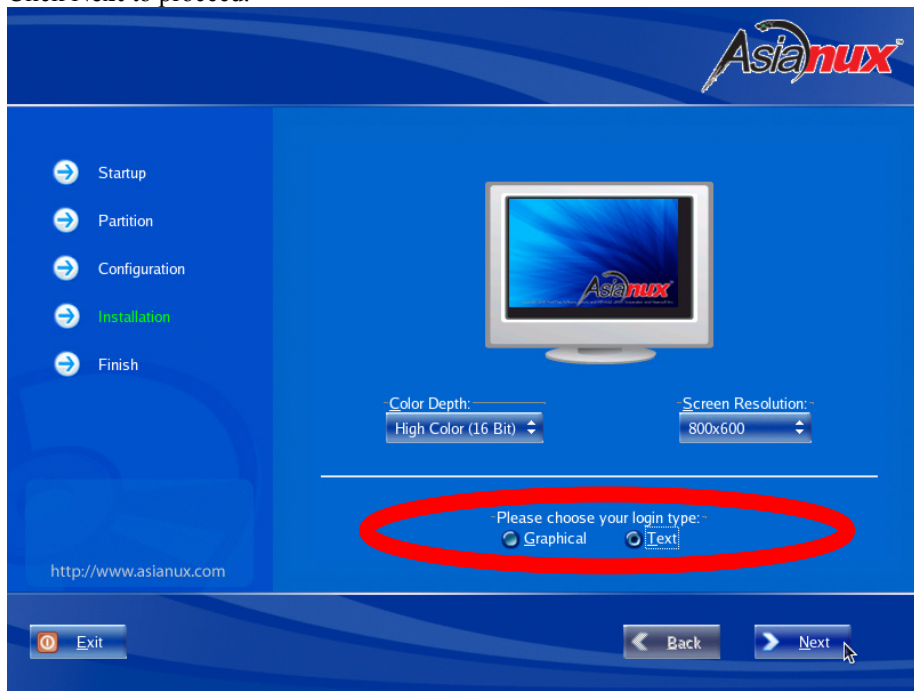

CHECK:

About the color quality and screen resolution settings:

When GeminiEngine Control Software is installed, the color quality and screen resolution are set as shown below. In order to change these settings, you need to change the kernel boot option. For details, see “SETTING THE VIDEO MODE” of Chapter 3 “Linux Setup and Operation” in the separate User’s Guide.

The color quality and screen resolution after installing GeminiEngine Control Software:

Color quality: High Color (16 bit)

Screen resolution: 1024x768

IMPORTANT:

After GeminiEngine Control Software is installed, never use the “kon” command.

After GeminiEngine Control Software is installed, never use the “startx” command. For switching the screen mode to the graphical mode, use the “init 5” command.

After the completion of the installation, follow the instruction and remove the medium. Click **Reboot** to restart the server.

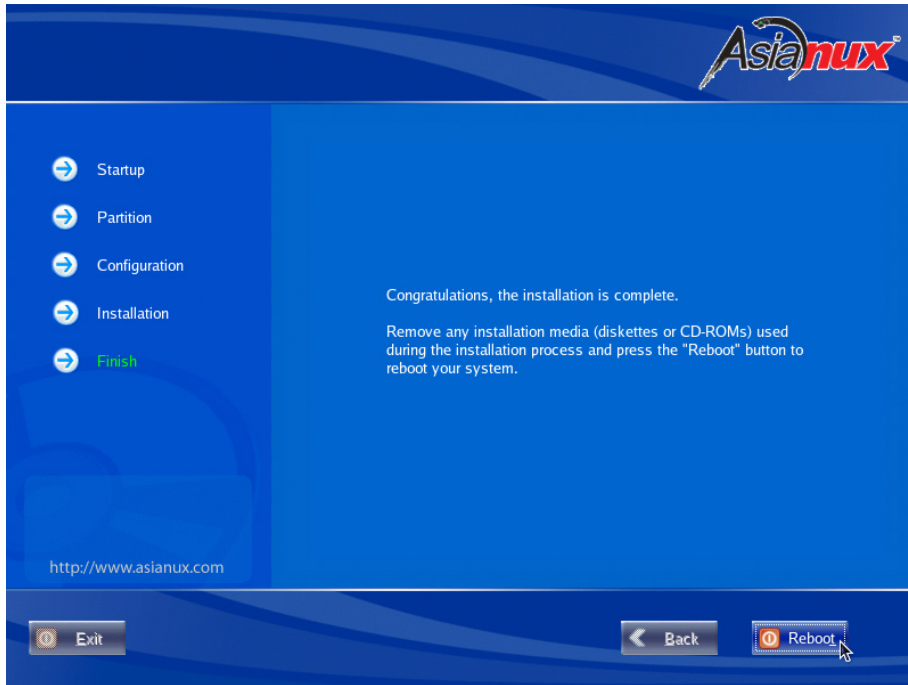

4. Install SP1.

Install SP1 in the graphical mode.

If the screen mode is not the graphical mode, log on as root and switch to the graphical mode using the following command:

```
# init 5
```

Perform the following operations by root.

In the following procedure, stop crond and anacron:

```
# service crond stop
```

```
# service anacron stop
```

IMPORTANT:

Set the MIRACLE LINUX V4.0 SP1 Install CD (1 of 2) to the drive. Then the CD-ROM is mounted and the installer is started automatically. If the installer is not started, mount the CD-ROM and start the installer as shown below:

```
# mount /media/cdrom
```

```
# /media/cdrom/autorun
```

Click **Next** to proceed.

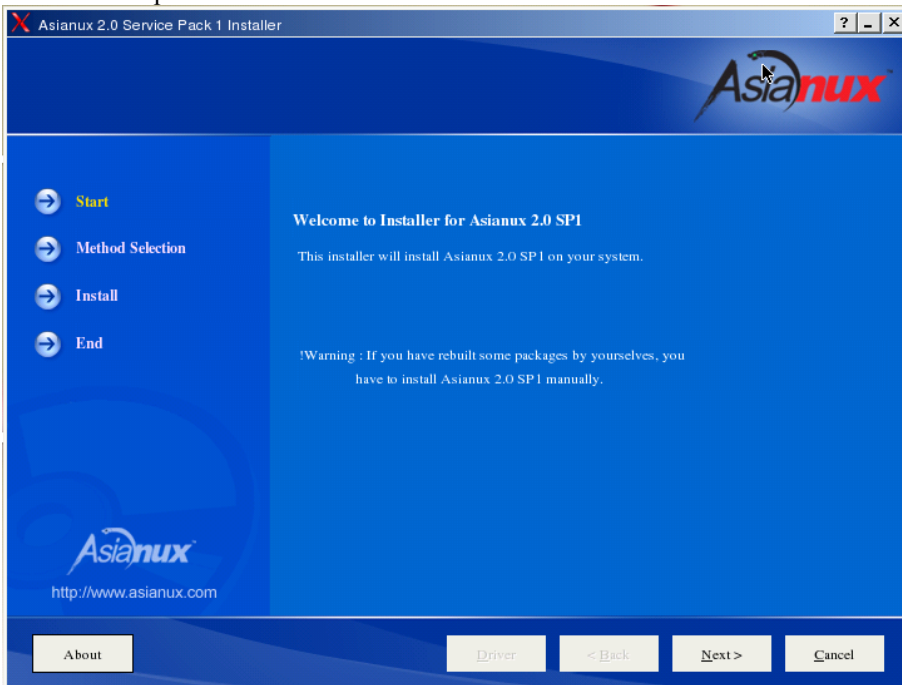

The setting does not need to be changed.

Select the **Install New Package** and **New Feature** check boxes as necessary.

Install New Package: Select this check box for installing packages that were not selected when installing MIRACLE LINUX V4.0.

New Feature: Select this check box for installing packages newly added since MIRACLE LINUX V4.0 SP1.

Click **Next** to proceed.

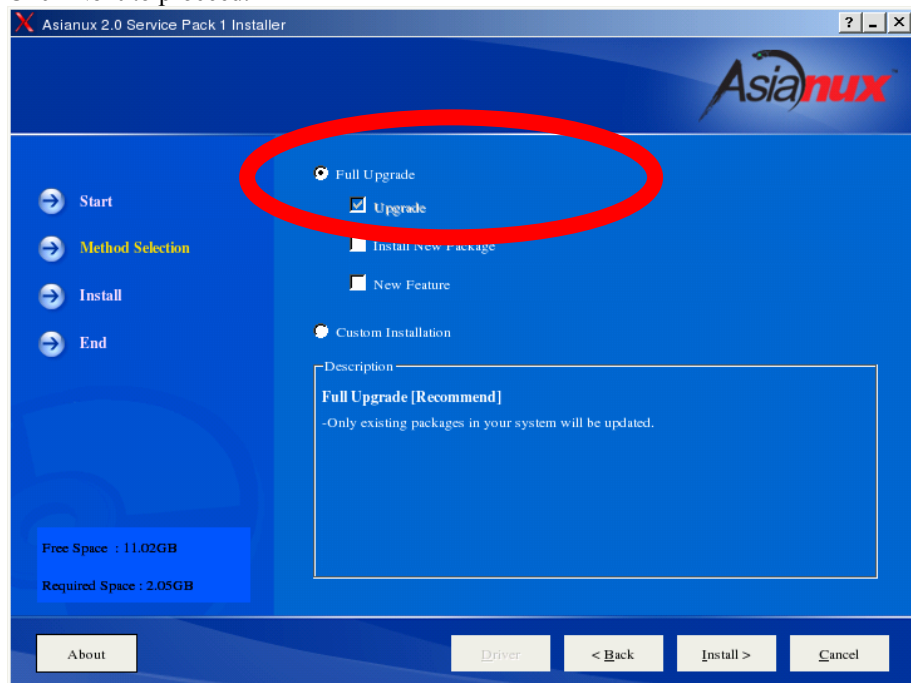

Click **Yes** to start upgrading.

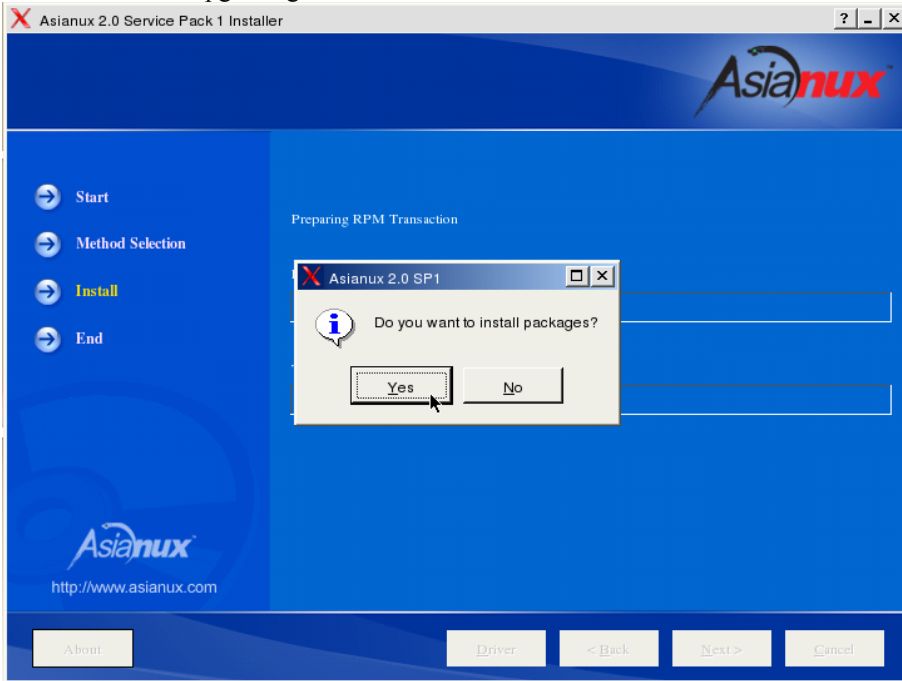

Click **Finish** to finish the installation.

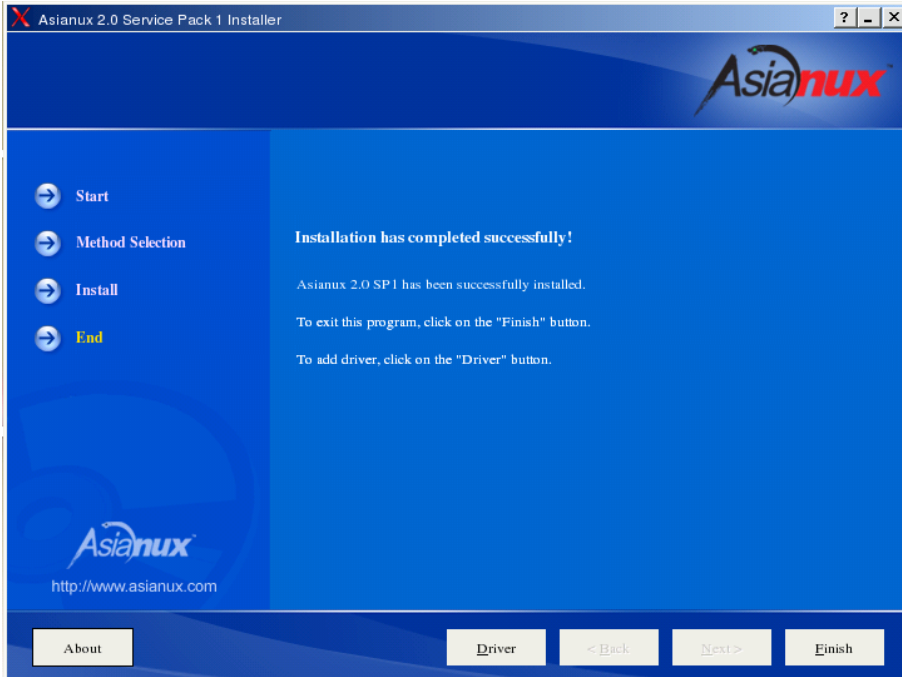

5. Restart the server.

6. Refer to the following example and change the device name in the diskdump partition configuration file (`/etc/sysconfig/diskdump`).

Example of editing `/etc/sysconfig/diskdump`:

```
DEVICE=/dev/sda5
DEVICE=/dev/sdb5
```

Edit the description above as follows:

```
DEVICE=/dev/hada5:/dev/hadb5
```

TIPS:

If the server is started from a module different from the previous startup, a setting screen for kudzu is opened, but no operation is required.

Step 5: Install Software Provided by NEC Express5800/ft series

IMPORTANT:

- Do not install “IPMI Management Utility.”
 - Do not install “OpenIPMI package.”
-

Follow the procedure below to install software provided by NEC Express5800/ft series:

1. Set the “NEC EXPRESSBUILDER” CD-ROM into the CD-ROM drive of the server.
2. Run the following command to mount the CD-ROM.
(This example assumes that the mount point is “`/mnt/cdrom`.”)

```
# mount /mnt/cdrom
```

3. Update HAL daemon.

IMPORTANT:

The CD-ROM contains an updated package of `hal-0.4.2-3.EL4`. If your version of HAL daemon is later than that, you do not need to update it.

[How to confirm your version]

```
# rpm -qa |grep hal
```

```
hal-0.4.2-3.EL4
```

```
hal-devel-0.4.2-3.EL4
```

```
hal-gnome-0.4.2-3.EL4
```

Perform the procedure below to update HAL daemon.

- 1) Run the following command to stop HAL daemon:

```
# service haldaemon stop
```

- 2) Run the following command to delete hal-devel and had-gnome:
rpm -e hal-devel
rpm -e hal-gnome
 - 3) Move to the directory where HAL is stored:
cd /mnt/cdrom/HASLINUX/ASIANUX/HAL
 - 4) Run the following command to update HAL:
rpm -U hal-0.4.2-4.EL4.1AX.i386.rpm
 - 5) Run the following command to install hal-devel and hal-gnome:
rpm -ivh hal-devel-0.4.2-4.EL4.1AX.i386.rpm
rpm -ivh hal-gnome-0.4.2-4.EL4.1AX.i386.rpm
 - 6) Run the following command to confirm each version after updating.
The updated versions are as follows:
rpm -qa |grep hal
hal-0.4.2-4.EL4.1AX
hal-devel-0.4.2-4.EL4.1AX
hal-gnome-0.4.2-4.EL4.1AX
 - 7) Run the following command to start HAL daemon;
service haldaemon start
4. Updted the kernel from “2.6.9-34.21AXsmp” to “2.6.9-34.28AXsmp.”
- 1) Move to the directory where the update kernel is stored.
cd /mnt/cdrom/ASIANUX/update
 - 2) Update the kernel.
rpm -ivh kernel-smp-2.6.9-34.28AX.i686.rpm
 - 3) Unmount the CD-ROM.
umount /mnt/cdrom
 - 4) Remove the CD from the CD-ROM drive.
 - 5) Restart the OS.
shutdown -r now
 - 6) When restarting the OS, select the Asianux (2.6.9-34.28AXsmp) kernel.
Check the version of the kernel started as follows:
uname -r
2.6.9-34.28AXsmp
5. Install the GeminiEngine Control Software package.
- 1) Set the “NEC EXPRESSBUILDER” CD-ROM into the CD-ROM drive.
 - 2) Mount the CD-ROM:
mount /mnt/cdrom

- 3) Move to the directory where the GeminiEngine Control Software package is stored:

```
# cd /mnt/cdrom/HASLINUX/ASIANUX/HASSETUP
```
- 4) Run the following command to install the package:

```
# ./NEC-HAS-Installer.run
```
- 5) After the installation is complete, enter “n” for “!!! Reboot now ? [y/n]:.”
6. Install the NEC ESMPRO Agent package.
 - 1) Move to the directory where the NEC ESMPRO Agent package is stored:

```
# cd /mnt/cdrom/ESMLINUX/ASIANUX/esmpro_sa
```
 - 2) Run the following command to install the package:

```
# ./Esmpro_install.sh
```
7. Install BMC FW Update Service.
 - 1) Move to the directory where BMC FW Update Service is stored:

```
# cd /mnt/cdrom/BMCTOOL/OnlineUp/ASIANUX/bmc_fw
```
 - 2) Run the following command to install the package:

```
# ./bmc_fw-install.sh
```
8. Run the following command to unmount the CD-ROM:

```
# umount /mnt/cdrom
```
9. Remove the CD-ROM from the CD-ROM drive of the server.
10. Restart the OS.

Step 6: Set Dual Configuration of LAN Cards

LAN configuration is not set after MIRACLE LINUX V4.0 SP1 is reinstalled. If you use a network, you need to set dual configuration of LAN cards.

The NEC Express5800/ft series builds a dual configuration of 1000BASE LAN cards that are controlled by the e1000 driver by using bonding, as bondX (X=0, 1, 2...).

1. Log on to the system as a root user.
2. The network interface name for MIRACLE LINUX V4.0 SP1 is assigned in the following format:

```
e[bus_number][device_number][function_number]
```

PCI slots and Network Interface Names

Slot	Port	CPU/IO module #0	CPU/IO module #1
Built-in	#1	e08030	e13030
	#2	e08031	e13031
PCI-1	#1	e07010	e12010
	(#2)	(e07011)	(e12011)
PCI-2	#1	e07020	e12020
	(#2)	(e07021)	(e12021)
PCI-3	#1	e07030	e12030
	(#2)	(e07031)	(e12031)

The ports in parentheses can be used when two-port NIC is installed.

For dual configuration, match the same port of the same slot for CPU/IO module #0 and CPU/IO module #1.

In 3, set dual configuration of e08030 (built-in network port #1 of CPU/IO module #0) and e13030 (built-in network port #1 of CPU/IO module #1) as “bond0.”

3. Settings values:

Bonding interface name: bond0
 SLAVE0 interface name: e08030
 SLAVE1 interface name: e13030
 IP address: 192.168.0.1
 Net mask: 255.255.255.0
 Broadcast: 192.168.0.255

4. Run the following command:

```
# bondctl add bond0

Bonding[bond0] network slave interfaces INPUT.

SLAVE0 interface (ex: e08030) = e08030
SLAVE1 interface (ex: e13030) = e13030

Bonding[bond0] network parameter INPUT.

DHCP ?[y/n]: n

IPADDR   = 192.168.0.1
NETMASK  = 255.255.255.0 ?[y/n]: y
BROADCAST = 192.168.0.255 ?[y/n]: y

Bonding set up with this parameter[y/n]?: y
Enslaving e08030 to bond0
Enslaving e13030 to bond0
```

5. Check the status of the bond:

```
# bondctl status
**** Bonding Network Status ****

bond      status      real      real
-----+-----+-----+-----
bond0     OKAY        *e08030   e13030

bond      real      status    link
-----+-----+-----+-----
bond0     *e08030   UP        LINK
          e13030   UP        LINK
```

When the status of bond0 with the LAN cable connected is “OKAY” as shown above, the dual configuration of the LAN cards is completed.

6. Run the following command to confirm that settings such as IP address are correct:

```
# bondctl status bond0

**** Bonding Network Status ****

bond      status real      real
-----+-----+-----+-----
bond0     OKAY   *e08030 e13030

bond0     Link encap:Ethernet HWaddr 00:30:13:63:10:2C
          inet addr:192.168.0.1 Bcast:192.168.0.255 Mask:255.255.255.0
          inet6 addr: fe80::200:ff:fe00:0/64 Scope:Link
          UP BROADCAST RUNNING MASTER MULTICAST MTU:1500 Metric:1
          RX packets:15717 errors:0 dropped:0 overruns:0 frame:0
          TX packets:9005 errors:0 dropped:0 overruns:0 carrier:0
          collisions:0 txqueuelen:0
          RX bytes:1474344 (1.4 MiB) TX bytes:2235181 (2.1 MiB)

bond      real      status link
-----+-----+-----+-----
bond0     *e08030   UP     LINK
          e13030   UP     LINK

e08030    Link encap:Ethernet HWaddr 00:30:13:63:10:2C
          inet6 addr: fe80::230:13ff:fe63:102c/64 Scope:Link
          UP BROADCAST RUNNING SLAVE MULTICAST MTU:1500 Metric:1
          RX packets:15380 errors:0 dropped:0 overruns:0 frame:0
          TX packets:9000 errors:0 dropped:0 overruns:0 carrier:0
          collisions:0 txqueuelen:1000
          RX bytes:1441797 (1.3 MiB) TX bytes:2234811 (2.1 MiB)
          Base address:0x5000 Memory:a4120000-a4140000

e13030    Link encap:Ethernet HWaddr 00:30:13:63:10:2C
          inet6 addr: fe80::230:13ff:fe63:102c/64 Scope:Link
          UP BROADCAST RUNNING NOARP SLAVE MULTICAST MTU:1500 Metric:1
          RX packets:337 errors:0 dropped:0 overruns:0 frame:0
          TX packets:5 errors:0 dropped:0 overruns:0 carrier:0
          collisions:0 txqueuelen:1000
          RX bytes:32547 (31.7 KiB) TX bytes:370 (370.0 b)
          Base address:0x9400 Memory:ac120000-ac140000
```

Supplement

Deleting the LAN board settings

Delete the LAN board settings as shown below:

```
# bondctl del bond0

Bond0    Link encap:Ethernet HWaddr 00:30:13:63:10:2D
         inet addr:192.168.0.1 Bcast:192.168.0.255 Mask:255.255.255.0
         inet6 addr: fe80::230:13ff:fe63:102d/64 Scope:Link
         UP BROADCAST RUNNING MASTER MULTICAST MTU:1500 Metric:1
         RX packets:0 errors:0 dropped:0 overruns:0 frame:0
         TX packets:0 errors:0 dropped:0 overruns:0 carrier:0
         collisions:0 txqueuelen:0
         RX bytes:0 (0.0 b) TX bytes:0 (0.0 b)

Slave ether interface:e08030,e13030

Bonding[bond1] and slave ether[e08030,e13030] really DELETE?[y/n]:y
Bonding[bond1] and slave ether[e08030,e13030] was DELETE.
```

Changing the LAN board settings

To change the LAN board settings, delete them and then make the settings again.

Step 7: Set Dual Disk Configuration

NEC Express5800/ft series secures data by making disks to RAID configuration.

Immediately after software provided with NEC Express5800/ft series is installed, dual configuration is set to the built-in disks for booting. However, make sure to check the status of dual disk configuration to prevent unexpected problems. If needed, set dual disk configuration.

IMPORTANT:

- Make sure to set RAID not only when installing an operating system but also when adding disks or reconstructing RAID.
 - When adding disks or reconstructing RAID, the status of each disk becomes “resync” or “recovery.” Do not insert/remove disks, turn off the power, or restart the system during this status. Wait until the status “resync” or “recovery” is finished. You can check the status of RAID using `ftdiskadm` described later.
-

Disk setup utility (ftdiskadm)

You can check the status of the integrated SCSI disk and set the RAID configuration safely by using disk setup utility (ftdiskadm).

By using ftdiskadm, you can:

- Check the status of all built-in disks
- Check the status of RAID of the built-in disks
- Recover RAID of the built-in disk
- Extend the built-in disk
- Detach the built-in disk

<Example>

```
#ftdiskadm
Command Action
 1 => RAID
 2 => SCSI
 9 Quit

Command:1

Command Action
 1 New Disks
 2 Remove Half Disk
 3 Repair Disk
 4 Remove Full Disks
 5 Status(Raid)
 6 Status(All Disks)
 9 <= Return

Command:
```

TIPS:

- ftdiskadm must be run by a root user.
 - If you attempt to start ftdiskadm more than once at a time, “Cannot start” is displayed. If this message is displayed even when only one ftdiskadm is started, it may have been terminated without clearing the information. In such a case, run ftdiskecleanup and then start ftdiskadm.
 - The trace log of ftdiskadm is recorded to the /var/log/ftdiskadm directory. If the files occupy a large part of the disk space, delete them from the oldest.
 - Boot disks are inserted into the Slot0 and Slot3 normally. If you can only boot the system in the simplex mode, insert a boot disk into the Slot0 and boot the system.
 - Use “RAID” - “Remove Full Disks” of ftdiskadm only when it is required because it deletes the md device from the system. To restore the deleted md device, the system needs to be restarted.
-

Check the status of the SCSI disk

Check the status of the SCSI disk using `ftdiskadm` command.

The following is an example of the display when “Status(All Disks)” of “=> RAID” is executed.

(Display example of the disk status)

```
[SCSI DISK STATUS]
-- SYSTEM --
slot name use serial path
0 hada 2 V3W1N8RA0050B5CL0399 h1c0t010ACT h7c0t010HOT
1 -
2 -
3 hadb 2 V3W1RK5A0050B5CK040D h2c0t310ACT h8c0t310HOT
4 -
5 -
```

slot : Slot number of the SCSI disk

name : Device name

use : Current mount count

serial : Serial number

path : SCSI path

<SCSI_path>=h<host_number>c<channel_number>t<target_number>l<LUN><path_status>

Check the status of the RAID disk

Check the status of the RAID disk using `fdiskadm` command.

The following is an example of the display when “Status(Raid)” (RAID status of the current disk) of “=> RAID” is executed.

(Display example of the RAID status)

[Status(Raid)]				
Name	Partition	Status	Member	
md6		resync=DELAYED	(2) hadc7	(5) hadd7
md5		resync=DELAYED	(2) hadc6	(5) hadd6
md4		resync4.4%	(2) hadc5	(5) hadd5
md3		duplex	(2) hadc1	(5) hadd1
md1	/	resync=DELAYED	(0) hada2	- (3) hadb2
md2		recovery64.5%	(0) hada3	- (3) hadb3
md0	/boot	duplex	(0) hada1	(3) hadb1

- Name** : Name of a software RAID device
- Partition** : Mount point or a swap. If this field is blank, RAID is configured but not mounted as a file system.
- Member** : Information of the member configuring RAID. The information will be displayed in the following format for the number of members.
(Slot_number) name
 If the status is error, “F” is marked on the left. In such a case, you need to fix RAID.
- Status** : Status of RAID. The following are the descriptions of the status messages.

Status	Description
duplex	Normal status
resyncxx.x%	Being synchronized. When completed, it becomes duplex.
recoveryxx.x%	Being recovered. The members with “-” mark on the member field have not been built yet.
resync=DELAYED	Waiting to be synchronized or recovered. The member with “-” mark on the member field is waiting to be recovered.
simplex	Only one side of RAID is built. If two members are displayed on the member field, the member with “-” mark is on standby before RECOVERY status. If only one member is displayed, recovery is required.

Add a SCSI disk to the system

Use `ftdiskadm` to add a SCSI disk to the system.

For “Which scsi SLOT?(0-5),” enter the number of a slot to which you want to add a disk.

(Example)

```
Command Action
 1 => RAID
 2 => SCSI
 9 Quit

Command:2

Command Action
 1 Bring Down(System Disk)
 2 Bring Up(System Disk)
 3 Status(System Disks)
 9 <= Return

Command:2

[Bring Up(System Disk)]
Which scsi SLOT?[0-5]:
```

Separating a SCSI disk from the system

Use `ftdiskadm` to separate a SCSI disk from the system.

For “Which scsi SLOT?(0-5),” enter the number of a slot of the disk which you want to separate from the system.

(Example)

```
Command Action
 1 => RAID
 2 => SCSI
 9 Quit

Command:2

Command Action
 1 Bring Down(System Disk)
 2 Bring Up(System Disk)
 3 Status(System Disks)
 9 <= Return

Command:1

[Bring Down(System Disk)]
Which scsi SLOT?[0-5]:
```

IMPORTANT:

- Never use the command that directly deletes SCSI disk for separating a SCSI disk. If you do, RAID cannot be recovered when the deleted SCSI disk is included in the md device.
 - Before disconnecting the boot disks (Slot0 and Slot3) from the system, remove the registration of the disk device that diskdump uses. Referring to “DUMP INITIALIZATION” in the separate User’s Guide, check the diskdump partition and remove the registration.
-

Step 8: Connect and Configure Options

When there are option PCI boards or peripheral devices to connect to the main unit, power off the main unit. Then, for connecting them, follow the instructions in “PCI board” in the separate volume of the User’s Guide and the manual of the devices.

TIPS:

If LAN cards or disks are added, you need to set dual configurations. For details, see “Step 6: Set Dual Configuration” (page 4-35) and “Step 9: Create Volume” (page 4-46).

Step 9: Create Volume

If you create a new volume on the expanded internal disk, see “System Upgrade” in the separate volume of the User’s Guide and configure RAID.

Step 10: Set Network for NEC ESMPRO Agent

NEC ESMPRO Agent is required for continuous operation of the NEC Express5800/ft series. It will be installed automatically when reinstalling the OS by using Linux for NEC Express5800/ft series Back Up CD-ROM.

To run NEC ESMPRO Agent, you need to make settings of the SNMP. For details and methods of the settings, see from “2. Environment settings of snmpd” to “5. Setting firewall” on “NEC ESMPRO Agent” of “Installing Management Utility.”

Step 11: Enable Boot Monitoring Function

When necessary for system operation, enable the “Boot Monitoring” setting which has been disabled in “Step 3: Disable the Startup Monitoring Function Setting” (page 4-6). See “Step 3: Disable the Startup Monitoring Function Setting” (page 4-6) and set appropriate time (default is 10 min.).

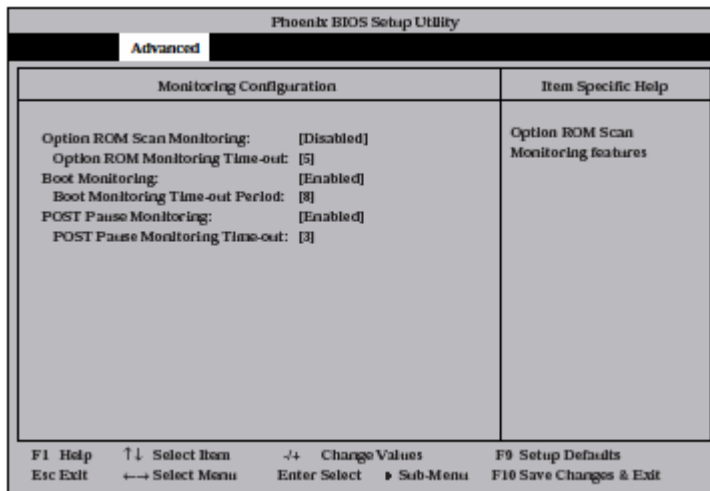

IMPORTANT:

For the following cases, boot monitoring function needs to be disabled for NEC Express5800/ft series. To disable it, see “Step 3: Disable the Startup Monitoring Function Setting.”

- To enter into the kudzu setup mode and make settings while the OS is starting.
- To change the boot mode to the interactive startup mode.

Note: You can change the interactive startup mode by entering the message “I” when “Press ‘I’ to enter interactive startup.” appears during the OS startup.

- When the system enters into the maintenance mode while the OS is starting.

Note: The following message is displayed on the screen:

Give root password for maintenance
(or type Control-D to continue):

- For other cases that daemons and/or drivers are not started successfully due to errors or other causes.

Step 12: Modify BIOS Setup

In this step, make settings suitable for running the Linux OS. These settings can optimize the visual display function.

IMPORTANT:

If you skip the settings described here, the screen may take longer to be displayed on the OS after actual memory capacity is increased.

TIPS:

For details of operations for BIOS Setup Utility and parameters, see the separate volume of User's Guide.

<Procedure for Changing BIOS settings>

1. Refer to “Step 3: Disable the Startup Monitoring Function Setting” and start the BIOS Setup Utility.

<Example>

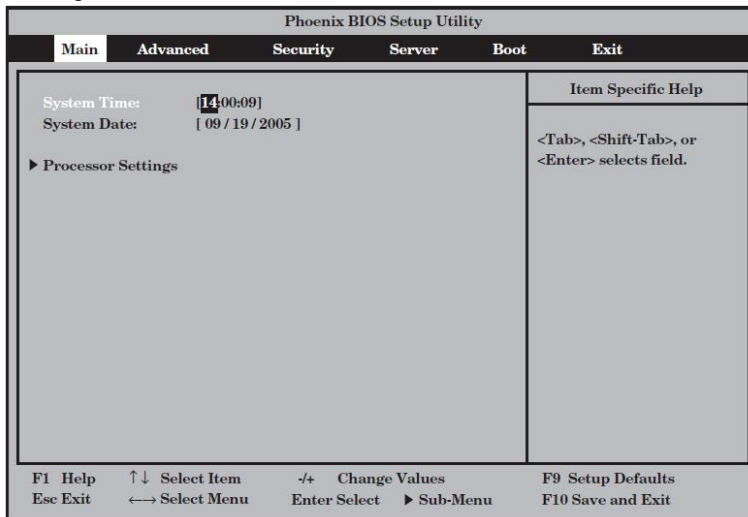

- Use the cursor keys (↑ and ↓) to select “Processor Settings,” and press **Enter** key. The Processor Settings submenu appears.

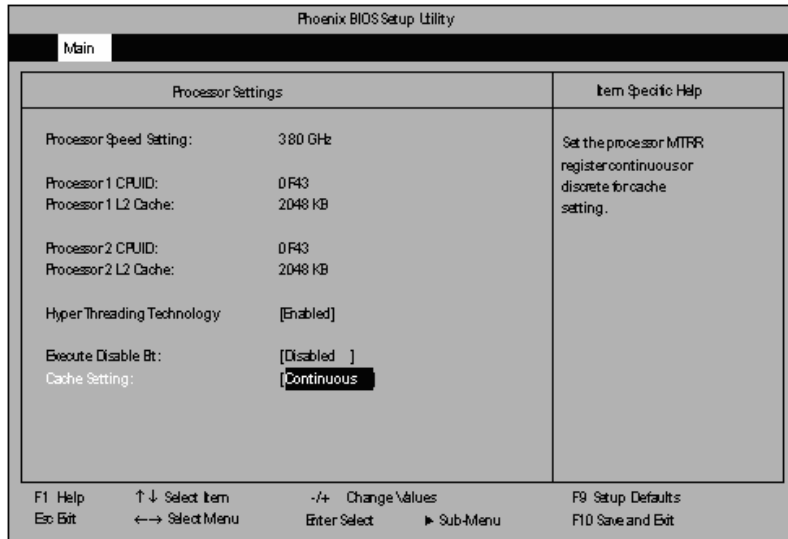

- Move the cursor onto “Cache Setting” and press **Enter**. Parameters will be displayed.
- Among the parameters, choose “Discrete” and press **Enter**. The current display of the configuration for Cache Setting will be changed to “Discrete.”

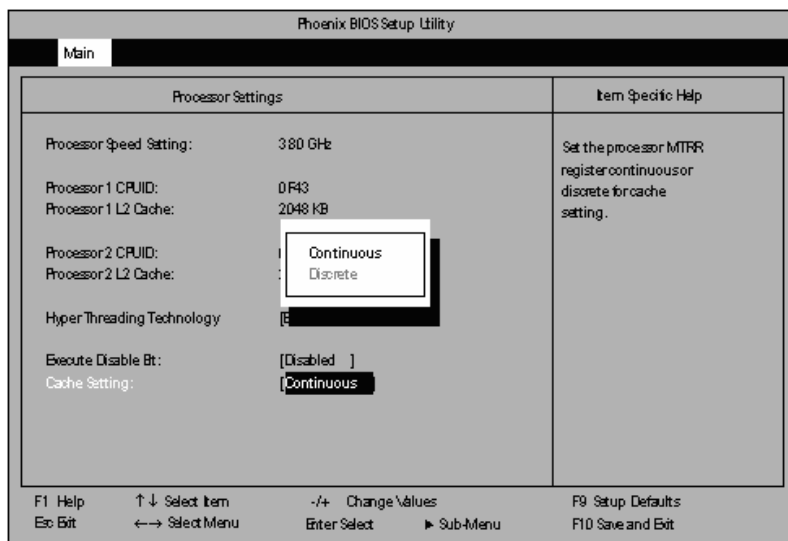

5. Press **Esc** twice to go back to the Main menu, and then move the cursor onto "Exit" to display the Exit menu.

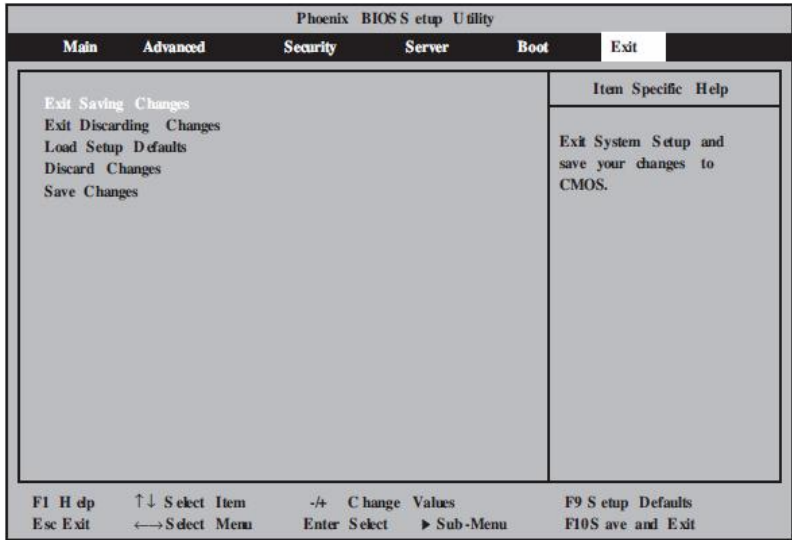

6. Move the cursor onto "Exit Saving Changes" and press **Enter**.
The confirmation window will appear.

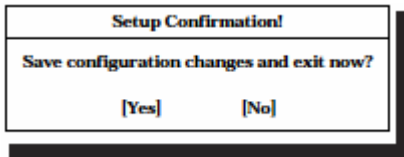

7. Select "Yes" and press **Enter**.
After the configuration data is saved and SETUP is terminated, the system is rebooted. This is the end of steps for switching boot monitoring function.

Step 13: Back up System Information

After setting up the system, back up the system information using the Off-line Maintenance Utility.

Without backup for system information, the information and settings that are specific to your server cannot be restored if the server is repaired. Take the following steps to make a backup copy of the system information:

1. Get a 3.5-inch floppy disk.
2. Insert the "NEC EXPRESSBUILDER" CD-ROM into the CD-ROM drive of the server, and restart the system.
NEC EXPRESSBUILDER is activated and [NEC EXPRESSBUILDER Top Menu] is displayed.
3. Select [Off-line Maintenance Utility] from [Tools].
4. Select [Save System NVRAM/ROM Data] from [System Information Management].

Follow the instructions you see on the screen.

The ft series setup is now completed.

(This page is intentionally left blank.)

Chapter 5

Procedures after Completion of Installation

This chapter describes what you do after installation including setup for failure management, how you install management utilities, how you back up system information, and setup of PCs on the network. You may need to confirm these procedures while the system is running.

INSTALLING MANAGEMENT UTILITIES

The “NEC EXPRESSBUILDER” CD-ROM is shipped with the NEC Express5800/ft series.

“NEC EXPRESSBUILDER” contains “NEC ESMPRO Manager” for managing the NEC Express5800 series and “NEC ESMPRO Agent” for managing NEC Express5800 series. Install and setup these utilities on the NEC Express5800/ft series or the computer (management PC) that manages the NEC Express5800/ft series.

NEC ESMPRO Agent

NEC ESMPRO Agent is a utility to monitor the operating status, the configuration information, the failure occurrence status of hardware and software on the NEC Express5800/ft series. When it detects some problems, it sends messages to the computer in which the NEC ESMPRO Manager is installed.

NEC ESMPRO Agent is automatically installed by installing the software provided with NEC Express5800/ft series. However, you still need to set up according to your environment for operating NEC ESMPRO Agent. See “Preparation before Setup” described later to set up.

IMPORTANT:

Make sure that NEC ESMPRO Agent is installed because it is indispensable for continuous operation of NEC Express5800/ft series.

Operation Environment

NEC ESMPRO Agent can be operated in the hardware and software environments shown below.

- Hardware
 - Installation system NEC Express5800/ft series
- Software

The following packages are required.

- net-snmp
- net-snmp-devel
- net-snmp-utils
- newt
- newt-devel
- portmap
- slang
- slang-devel

Preparation before Setup

Be sure to read the following before system installation or setup.

To operate NEC ESMPRO Agent, each service must be installed appropriately and must be operating.

1. Check necessary packages

The following packages are needed to use NEC ESMPRO Agent.

If there are any packages which are not installed, install them.

- net-snmp
- net-snmp-devel
- net-snmp-utils
- newt
- newt-devel
- portmap
- slang
- slang-devel

2. Environment settings of snmpd

Modify the environment setting file of snmpd (/etc/snmp/snmpd.conf) to set a community right to more than "READ WRITE."

Correct the environment setting using the vi command, etc., referring to the following.
For details of the settings, refer to the online help of snmpd.

```
####
```

```
# Third, create a view for us to let the group have rights to:
```

```
#          name    incl/excl    subtree    mask(optional)
view      all      included    .1         80
```

```
####
```

```
# Finally, great the group read-only access to the systemview view.
```

```
#          group    context    sec.model sec.level    prefix read    write notif
access    notConfigGroup    ""           any         noauth    exact    all    all
none
```

3. Start setting of snmpd

Set snmpd to start automatically.

```
# /sbin/chkconfig --level 345 snmpd on
```

4. Start setting of portmap

Set portmap to start automatically.

```
# /sbin/chkconfig --level 345 portmap on
```

5. Setting firewall

When monitoring from the NEC ESMPRO Manager, use the following port.

If you set the firewall on your environment, set the access permission to the following port.

```
snmp          161/udp
snmp-trap     162/udp
```

Installation procedure

TIPS:

NEC ESMPRO Agent is automatically installed by installing the software provided with NEC Express5800/ft series.

1. Log in to the system as a root user.
2. Set the NEC EXPRESSBUILDER to the CD-ROM drive.
3. Enter the following command to mount the CD-ROM.

In this example, the mount point is assumed to be "mnt/cdrom."

```
# mount /mnt/cdrom
```

4. Move to the directory where the package of the NEC ESMPRO Agent is stored.

```
# cd /mnt/cdrom/ESMLINUX/ASIANUX/esmpro_sa
```

5. Run the following command to install the package:

```
# ./Esmpro_install.sh
```

6. Restart the OS.

Uninstallation procedure

1. Log in to the system as a root user.
2. Run the following command to uninstall the package:

```
# ./Esmpro_remove.sh
```

3. Restart the OS

Setup of NEC ESMPRO Agent

Follow the instructions below to setup the NEC ESMPRO Agent.

1. Log in to the system as a root user.
2. Move to the directory where the NEC ESMPRO Agent is installed.

```
cd /opt/nec/esmpro_sa
```

3. Move to the directory where the control panel is stored.

```
cd bin
```

4. Start the control panel.

```
./ESMagntconf
```

The screen of the control panel will appear.



Report Setting

To report from the NEC ESMPRO Agent to the NEC ESMPRO Manager, you need to set the method of report.

Setting of Manager (SNMP)

1. Log in the system as a root user.
2. Move to the directory where the NEC ESMPRO Agent is installed.

```
cd /opt/nec/esmpro_sa
```

3. Move to the directory where the Report Setting tool is stored.

```
cd bin
```

4. Start the Report Setting tool.

```
./ESMamsadm
```

The [Report Setting] screen will appear.



5. Select [Base Setting].

The [Base Setting] screen will appear.

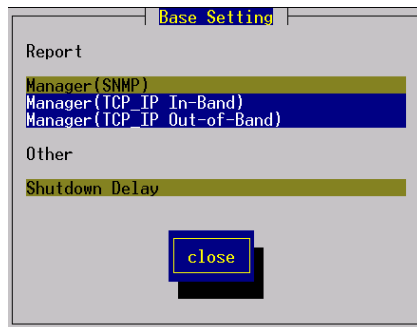

6. Select [Manager (SNMP)].

The [SNMP Trap Setting] screen will appear.

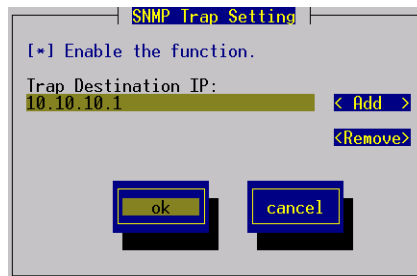

7. Enable [Enable the function].

Set enable/disable using space key. When checked, it is enabled. When not checked, it is

disabled.

- 8.** Select [Add] to set [Trap Destination IP].

Set the IP address of the device where the NEC ESMPRO Manager is installed.

- 9.** Finish the tool.

The report will be performed to the NEC ESMPRO Manager.

NEC ESMPRO Manager

Linked with NEC ESMPRO Agent installed in the server, NEC ESMPRO Manager monitors the server status and receives alerts from the server.

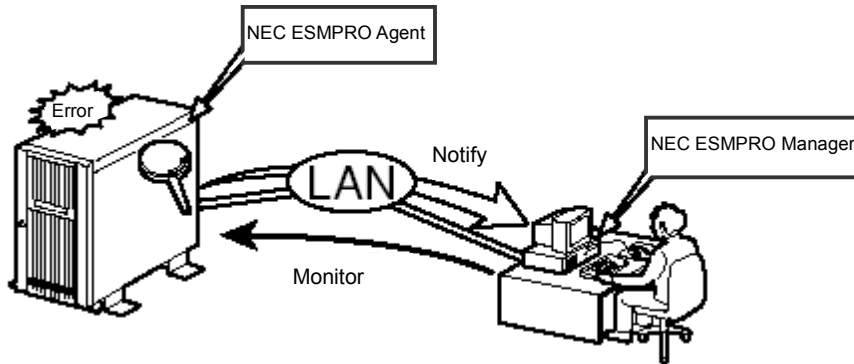

When a failing module in the server is to be replaced, NEC ESMPRO Manager enables logical module disconnection from the server and logical installation after module replacement.

For the installation of NEC ESMPRO Manager and notes on the operation, see the separate volume of User's Guide.

NEC DianaScope

NEC DianaScope is software to remotely manage the server.

The server can be managed remotely, only when N8815-001A ft Remote Management Card (optional for 320Fb-L/320Fb-LR) is installed.

For information on the functions and installation procedures of NEC DianaScope, refer to the online documents.

CONFIRMATION OF THE KERNEL VERSION

The following explains how to check the version of the kernel which is the core of the software achieving fault tolerance. Perform this procedure when you need to check the version of the operating kernel. (e.g., when you add devices to the NEC Express5800/ft series.)

A dedicated tool for checking the version is provided. Confirm the version following the procedure below:

1. Execute the following command:

```
> uname -a
```

The version of the operating kernel is displayed.

This completes confirmation of the version.

(This page is intentionally left blank.)

Chapter 6

Troubleshooting

This chapter describes what to do when files needed to operate the OS are damaged and any trouble occur on the product.

SYSTEM REPAIR

For procedure of repairing RAID when disk failures occur, refer to Chapter 4 “Linux Setup” (page 4-1).

IMPORTANT:

- If hard disks cannot be recognized, the system cannot be repaired.
 - You need to log in as a root user to make this setting.
-

If fsck was started while booting and was stopped during the process, execute fsck for each md devices.

```
>fsck -y /dev/md*
```

*: md number

TROUBLESHOOTING

This section describes what you should do when a trouble occurs in the product.

Problems with NEC EXPRESSBUILDER

When the server is not booted from the NEC EXPRESSBUILDER CD-ROM, check the following:

- Did you set the NEC EXPRESSBUILDER during POST and restart the server?
 - If you do not set the NEC EXPRESSBUILDER during POST and restart the server, an error message will appear or the OS will boot.
- Is BIOS configuration correct?
 - The boot device order may be specified with the BIOS setup utility of the server. Use the BIOS setup utility to change the boot device order to boot the system from the CD-ROM drive first.

<Menu to check: [Boot]>

When an error occurs while the NEC EXPRESSBUILDER is in progress, the following message appears. After this message appears, check the error and take the appropriate corrective action according to the error codes listed in the table below.

Message	Cause and Remedy
This machine is not supported.	This NEC EXPRESSBUILDER version is not designed for this server. Execute the NEC EXPRESSBUILDER on the compliant server.
NvRAM access error	An access to the nonvolatile memory (NvRAM) is not acceptable.
Hard disk access error	The hard disk is not connected or it is failed. Check whether the hard disk is correctly connected.
The system-specific information does not exist on the baseboard. Please restore the backup data or write the data by using [System Information Management] of the Off-line Maintenance Utility. Only the authorized personnel are allowed to do this operation.	The system-specific information cannot be acquired by replacing the motherboard or other device.

An error message will also be displayed when an error was detected during system diagnosis. Take a note or print the error message displayed, and contact your sales agent.

(This page is intentionally left blank.)

Appendix A

About Services

Information on NEC Express5800/ft series is provided the web at NEC Express5800 Web ASIA
PACIFIC

<http://www.nec.co.jp/express/>

N8800-100F, EXP320B

NEC Express5800/320Fb-L

N8800-101F, EXP320A

NEC Express5800/320Fb-LR

User's Guide (Setup)

1st Edition

1-2007

856-126409-102-00



856-126409-102-00